

Keysight X-Series Signal Analyzers

This manual provides documentation for the following Analyzers:

PXA Signal Analyzer N9030A
EXA Signal Analyzer N9010A

MXA Signal Analyzer N9020A
CXA Signal Analyzer N9000A

Notice: This document contains references to Agilent. Please note that Agilent's Test and Measurement business has become Keysight Technologies. For more information, go to www.keysight.com.

N6155A &
W6155A ISDB-T
Measurement
Application
Measurement
Guide

Notices

© Keysight Technologies, Inc.
2008-2014

No part of this manual may be reproduced in any form or by any means (including electronic storage and retrieval or translation into a foreign language) without prior agreement and written consent from Keysight Technologies, Inc. as governed by United States and international copyright laws.

Trademark Acknowledgements

WiMAX™, WiMAX Forum®, the WiMAX Forum Logo, Mobile WiMAX™, WiMAX Forum Certified™, the WiMAX Forum Certified Logo, and Fixed WiMAX™ are US trademarks of the WiMAX Forum.

Manual Part Number

N6155-90002

Print Date

August 2014

Supersedes: February 2012

Printed in USA

Keysight Technologies Inc.
1400 Fountaingrove Parkway
Santa Rosa, CA 95403

Warranty

THE MATERIAL CONTAINED IN THIS DOCUMENT IS PROVIDED “AS IS,” AND IS SUBJECT TO BEING CHANGED, WITHOUT NOTICE, IN FUTURE EDITIONS. FURTHER, TO THE MAXIMUM EXTENT PERMITTED BY APPLICABLE LAW, KEYSIGHT DISCLAIMS ALL WARRANTIES, EITHER EXPRESS OR IMPLIED WITH REGARD TO THIS MANUAL AND ANY INFORMATION CONTAINED HEREIN, INCLUDING BUT NOT LIMITED TO THE IMPLIED WARRANTIES OF MERCHANTABILITY AND FITNESS FOR A PARTICULAR PURPOSE. KEYSIGHT SHALL NOT BE LIABLE FOR ERRORS OR FOR INCIDENTAL OR CONSEQUENTIAL DAMAGES IN CONNECTION WITH THE FURNISHING, USE, OR PERFORMANCE OF THIS DOCUMENT OR ANY INFORMATION CONTAINED HEREIN. SHOULD KEYSIGHT AND THE USER HAVE A SEPARATE WRITTEN AGREEMENT WITH WARRANTY TERMS COVERING THE MATERIAL IN THIS DOCUMENT THAT CONFLICT WITH THESE TERMS, THE WARRANTY TERMS IN THE SEPARATE AGREEMENT WILL CONTROL.

Technology Licenses

The hardware and/or software described in this document are furnished under a license and may be used or copied only in accordance with the terms of such license.

Restricted Rights Legend

If software is for use in the performance of a U.S. Government prime contract or subcontract, Software is delivered and licensed as “Commercial computer software” as defined in DFAR 252.227-7014 (June 1995), or as a “commercial item” as defined in FAR 2.101(a) or as “Restricted computer software” as defined in FAR 52.227-19 (June 1987) or any equivalent agency regulation or contract clause. Use, duplication or disclosure of Software is subject to Keysight Technologies’ standard commercial license terms, and non-DOD Departments and Agencies of the U.S. Government will receive no greater than Restricted Rights as defined in FAR 52.227-19(c)(1-2) (June 1987). U.S. Government users will receive no greater than Limited Rights as defined in FAR 52.227-14 (June 1987) or DFAR 252.227-7015 (b)(2) (November 1995), as applicable in any technical data.

Safety Notices

CAUTION

A **CAUTION** notice denotes a hazard. It calls attention to an operating procedure, practice, or the like that, if not correctly performed or adhered to, could result in damage to the product or loss of important data. Do not proceed beyond a CAUTION notice until the indicated conditions are fully understood and met.

WARNING

A **WARNING** notice denotes a hazard. It calls attention to an operating procedure, practice, or the like that, if not correctly performed or adhered to, could result in personal injury or death. Do not proceed beyond a WARNING notice until the indicated conditions are fully understood and met.

Where to Find the Latest Information

Documentation is updated periodically. For the latest information about these products, including instrument software upgrades, application information, and product information, browse to one of the following URLs, according to the name of your product:

<http://www.keysight.com/find/pxa>

<http://www.keysight.com/find/mxa>

<http://www.keysight.com/find/exa>

<http://www.keysight.com/find/cxa>

To receive the latest updates by email, subscribe to Keysight Email Updates at the following URL:

<http://www.keysight.com/find/emailupdates>

Information on preventing analyzer damage can be found at:

<http://www.keysight.com/find/tips>

Is your product software up-to-date?

Periodically, Keysight releases software updates to fix known defects and incorporate product enhancements. To search for software updates for your product, go to the Keysight Technical Support website at:

<http://www.keysight.com/find/techsupport>

Table of Contents

1 About the N6155A & W6155A ISDB-T Measurement Application

What Does the ISDB-T Measurement Application Do?	10
--	----

2 Making ISDB-T/Tsb/Tmm Measurements

Setting Up and Making a Measurement	12
Making Initial Connection and Configuring the Measurement System	12
Using Analyzer Mode and Measurement Presets	12
The 3 Steps to Set Up and Make Measurements	12
ISDB-T/Tsb/Tmm Transmitter Measurements	15
Configuring the Measurement System	15
Channel Power Measurements	17
ACP Measurements	22
Power Stat CCDF Measurements	24
Spectrum Emission Mask Measurements	27
Modulation Accuracy Measurements	31
Occupied Bandwidth Measurements	59
Monitor Spectrum Measurements	61
IQ Waveform (Time Domain) Measurements	65
ISDB-T/Tsb/Tmm SFN Field Measurements	68
Setting Up the Test System	68
ISDB-T Signal Under Test	68
Measurement Procedure	69
Using Option BBA Baseband I/Q Inputs	73
Baseband I/Q Measurements Available for X-Series Signal Analyzers	73
Baseband I/Q Measurement Overview	74
Measuring Low IF Signals with BBIQ Input	76

3 Concepts

ISDB-T/Tsb Technical Overview	80
-------------------------------	----

Contents

Hierarchical Transmission and Partial Reception	81
Interleaving	82
OFDM	82
ISDB-Tmm Technical Overview	84
Channel Power Measurement Concepts	86
Purpose	86
Measurement Method	86
Adjacent Channel Power (ACP) Measurement Concepts	87
Purpose	87
Measurement Method	87
Power Statistics CCDF Measurement Concepts	88
Purpose	88
Measurement Method	88
Spectrum Emission Mask Measurement Concepts	90
Purpose	90
Measurement Method	90
Modulation Accuracy Measurement Concepts	96
Purpose	96
Measurement Method	96
Definition of the Measurement Parameter	97
Occupied Bandwidth Measurement Concepts	103
Purpose	103
Measurement Method	103
Monitor Spectrum Measurement Concepts	104
Purpose	104
Measurement Method	104
Troubleshooting Hints	104
IQ Waveform Measurement Concepts	105
Purpose	105
Measurement Method	105
Baseband I/Q Inputs (Option BBA) Measurement Concepts	106
What are Baseband I/Q Inputs?	106

What are Baseband I/Q Signals?	107	
Why Make Measurements at Baseband?	107	
Selecting Input Probes for Baseband Measurements		108
Baseband I/Q Measurement Views	109	
Other Sources of Measurement Information	111	
Instrument Updates at www.keysight.com	111	
References	112	

1 About the N6155A & W6155A ISDB-T Measurement Application

The N6155A (for PXA, MXA, and EXA) & W6155A (for CXA) ISDB-T Measurement Application offers two options:

a. N6155A-2FP/W6155A-2FP ISDB-T measurement application

This option supports measurements on ISDB-T and ISDB-Tsb signals.

b. N6155A-3FP/W6155A-3FP ISDB-Tmm measurement application

Used together with the 2FP option, this option supports measurements on ISDB-Tmm signals.

Note that as the bandwidth of the ISDB-Tmm signal can be up to 14.5 MHz, make sure the analysis bandwidth of the signal analyzer is more than that value, which means that at least B25 (Extend the analysis bandwidth to 25 MHz) option needs to be installed in the instrument.

NOTE

The "FP" in the option name is short for fixed perpetual, which means you can only install the license key on the specific instruments for which it was created. For PXA, MXA, and EXA, there is another license type called "TP", short for transportable perpetual, which means you can transport this license key between instruments.

The transportable licenses for the two N6155A options are N6155A-2TP and N6155A-3TP. In this document, all the features and functions for N6155A-2FP, N6155A-3FP also apply to N6155A-2TP, N6155A-3TP.

ISDB-T (Integrated Services Digital Broadcasting - Terrestrial) is a digital terrestrial broadcasting standard developed in Japan.

ISDB-Tsb (Terrestrial Sound Broadcasting) is a standard for narrowband ISDB-T transmission system, which focuses on audio programs and data programs transmission.

ISDB-Tmm (Terrestrial Mobile Multi-media) is a standard for nationwide mobile multimedia broadcasting in Japan, which is scheduled to use 207.5 ~222 MHz bandwidth.

What Does the ISDB-T Measurement Application Do?

The ISDB-T measurement application allows the analyzer to be used for testing an ISDB-T/Tsb/Tmm transmitter and for ISDB-T/Tsb/Tmm field test in SFN (single frequency network) scenarios.

This application is manufactured according to the following documents:

- ARIB STD-B31 Transmission System for Digital Terrestrial Television Broadcasting
- ARIB STD-B29 Transmission System for Digital Terrestrial Sound Broadcasting
- ARIB STD-B46 Transmission System Based on Connected Segments for Terrestrial Mobile Multimedia Broadcasting
- ABNT NBR 15601 Brazilian Standard: Digital terrestrial television - Transmission System
- JEITA handbook: Methods of Measurement for Digital Terrestrial Broadcasting Transmitters

These documents define complex, multi-part measurements to create an interference-free environment and to ensure high quality transmission. For example, the documents standardize the test methods for transmitting power, shoulder attenuation, ACP, spectrum emission mask, MER, and other critical measurements.

The analyzer automatically makes these measurements according to the methods defined in the documents. The detailed measurement results displayed enable you to analyze the ISDB-T/Tsb/Tmm transmitter's performance. You can also alter the measurement parameters for specialized analysis.

This analyzer makes the following measurements of ISDB-T/Tsb/Tmm signals:

- Channel Power
- ACP
- Power Stat CCDF
- Spectrum Emission Mask
- Mod Accuracy
- Occupied BW
- Monitor Spectrum
- IQ Waveform

If the option BBA is installed, you can analyze baseband I/Q signal characteristics of ISDB-T/Tsb/Tmm signals. The baseband I/Q analysis is available in the following measurements:

- Power Stat CCDF
- Modulation Accuracy
- IQ Waveform

2 Making ISDB-T/Tsb/Tmm Measurements

This chapter begins with instructions common to all measurements, and then illustrates how to make measurements supported by N6155A/W6155A ISDB-T measurement application, including ISDB-T/Tsb/Tmm transmitter tests and ISDB-T/Tsb/Tmm field tests in SFN scenarios.

- “Setting Up and Making a Measurement” on page 12
- “ISDB-T/Tsb/Tmm Transmitter Measurements” on page 15
 - “Channel Power Measurements” on page 17
 - “ACP Measurements” on page 22
 - “Power Stat CCDF Measurements” on page 24
 - “Spectrum Emission Mask Measurements” on page 27
 - “Modulation Accuracy Measurements” on page 31
 - “Occupied Bandwidth Measurements” on page 59
 - “Monitor Spectrum Measurements” on page 61
 - “IQ Waveform (Time Domain) Measurements” on page 65
- “ISDB-T/Tsb/Tmm SFN Field Measurements” on page 68

Setting Up and Making a Measurement

Making Initial Connection and Configuring the Measurement System

CAUTION

Before connecting an ISDB-T/Tsb/Tmm signal to the analyzer, make sure the analyzer can safely accept the signal level provided. The maximum signal level limits are marked next to the RF Input connectors on the front panel.

After finishing the connection, see the **Input/Output** menu for details on selecting input ports and **AMPTD Y Scale** menu for details on setting internal attenuation to prevent overloading of the analyzer.

Using Analyzer Mode and Measurement Presets

To set your current measurement mode to a known factory default state, press **Mode Preset**. This initializes the analyzer mode by returning the mode setup and all of the measurement setups in that mode to the factory default parameters.

To preset the parameters that are specific to an active, selected measurement, press **Meas Setup, Meas Preset**. This returns all the measurement setup parameters to the factory defaults, but only for the currently selected measurement.

The 3 Steps to Set Up and Make Measurements

Generally speaking, all measurements can be set up using the following three steps in [Table 2-1](#). [Table 2-2](#) shows the main keys and functions that may be used while following the steps. For the detailed procedures for specific measurement, refer to:

- “Channel Power Measurements” on page 17
- “ACP Measurements” on page 22
- “Power Stat CCDF Measurements” on page 24
- “Spectrum Emission Mask Measurements” on page 27
- “Modulation Accuracy Measurements” on page 31
- “Occupied Bandwidth Measurements” on page 59
- “Monitor Spectrum Measurements” on page 61
- “IQ Waveform (Time Domain) Measurements” on page 65



NOTE Press  on the front panel to enter the help system and see detailed descriptions for the keys you are not familiar with. Press  on the front panel to exit the help system.

Table 2-1 *The 3 Steps to Set up and Make a Measurement*

Step	Action	Notes
1 Select and Set Up the Mode	<ul style="list-style-type: none"> a. Press Mode. b. Press a mode key, like Spectrum Analyzer, IQ Analyzer (Basic), or ISDB-T. c. Press Mode Preset. d. Press Mode Setup. 	<p>All licensed, installed modes available are shown under the Mode key.</p> <p>Using Mode Setup, make any required adjustments to the mode settings. These settings will apply to all measurements in the mode.</p>
2 Select and Set Up the Measurement	<ul style="list-style-type: none"> a. Press Meas. b. Select the specific measurement to be performed. c. Press Meas Setup. 	<p>The resulting data is shown on the display or is available for export.</p> <p>Use Meas Setup to make any required adjustment to the selected measurement settings. The settings only apply to this measurement.</p>
3 Select and Set Up a View of the Results	<p>Press View/Display. Set display format and select a view for the current measurement data.</p>	<p>Depending on the mode and measurement selected, other graphical and tabular data presentations may be available.</p> <p>Use Span X Scale and AMPTD Y Scale to adjust the display of the measurement graphics.</p>

NOTE You can change the settings as needed, and the changes will be in effect on the next measurement cycle or view.

Making ISDB-T/Tsb/Tmm Measurements
Setting Up and Making a Measurement

Table 2-2 *Main Keys and Functions for Making Measurements*

Step	Primary Key	Setup Keys	Related Keys
1 Select and set up a mode.	Mode	Mode Setup, FREQ Channel	System
2 Select and set up a measurement.	Meas	Meas Setup	BW, Sweep/Control, Restart, Single, Cont
3 Select and set up a view of the results.	View/Display	SPAN X Scale, AMPTD Y Scale	Peak Search, Quick Save, Save, Recall, File, Print

NOTE

If you encounter a problem, or get an error message, see the guide “**Instrument Messages**”, which is provided on the Documentation CD ROM, and in the instrument here:

C:\Program Files\Keysight\SignalAnalysis\Infrastructure\Help\bookfiles.

ISDB-T/Tsb/Tmm Transmitter Measurements

This section describes how to make measurements on ISDB-T/Tsb/Tmm transmitters. It includes configurations of the measurement system, test signal settings, detailed procedure of each measurement, and measurement results.

Configuring the Measurement System

Set the ISDB-T/Tsb/Tmm transmitter under test to transmit RF power. This transmitting signal is connected to the RF input port of the instrument. Connect the equipment as below.

CAUTION

Before connecting an ISDB-T/Tsb/Tmm signal to the analyzer, make sure the analyzer can safely accept the signal level provided. The maximum signal level limits are marked next to the RF Input connectors on the front panel.

1. Connect the output signal of the ISDB-T/Tsb/Tmm transmitter to the RF input port of the analyzer using appropriate cables, attenuators, and adapters.
2. (Optional) If there is a frequency reference port on the ISDB-T/Tsb/Tmm transmitter, connect it to the EXT REF IN port of the analyzer with a cable for frequency synchronization.

Figure 2-1

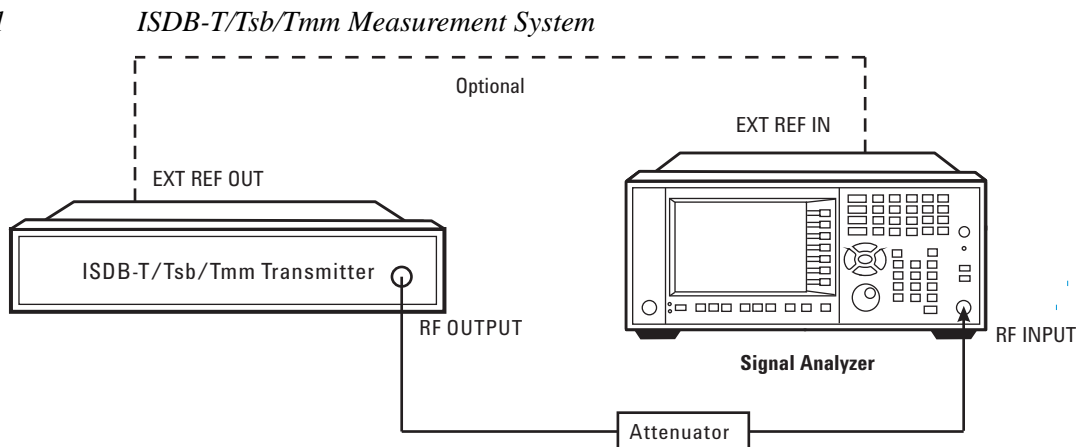

After finishing the connection, see the **Input/Output** menu for details on selecting input ports and **AMPTD Y Scale** menu for details on setting internal attenuation to prevent overloading of the analyzer.

NOTE

The parameters under **Input/Output** menu cannot be reset by pressing **Mode Preset**. Then if you have made any changes to Input/output parameters which are not required in another measurement, remember to restore these settings manually.

Setting the ISDB-T/Tsb/Tmm Transmitter (Example for Power Measurements)

Set up the ISDB-T/Tsb/Tmm transmitter to transmit the RF power as below.

Standard: ISDB-T

Frequency: 713.142857 MHz

(Channel Num: 53, Channel Table: NTSC-J AIR)

Channel bandwidth: 6 MHz

Attenuator: 60 dB

Transmitted Power: 40 dBm (at RF output); -20 dBm (at the analyzer input)

Channel Power Measurements

This section explains how to make a Channel Power measurement on an ISDB-T/Tsb/Tmm transmitter. Channel Power measurements show the spectrum, the total RF power, and the shoulder attenuation of the signal.

Step	Notes
1 Press Mode, ISDB-T .	
2 Press Mode Preset .	
3 Press Mode Setup, Radio Std, ISDB-T .	<p>This selects the radio standard for the signal under test. The standards available for selection under Radio Std menu depend on the licenses installed in your instrument:</p> <ul style="list-style-type: none"> • If only N6155A-2FP (W6155A-2FP for CXA) is installed, two standards are available: ISDB-T and ISDB-Tsb. • If both N6155A-2FP (W6155A-2FP for CXA) and N6155A-3FP (W6155A-3FP for CXA) are installed, three standards are available: ISDB-T, ISDB-Tsb, and ISDB-Tmm. <p>Note that if the Radio Std is set to ISDB-Tmm, the center frequency is changed to 214.714286 MHz automatically as specified in the ISDB-Tmm standard.</p>
<p>4 Do one of the following to set center frequency:</p> <ul style="list-style-type: none"> • Press FREQ Channel, Center Freq, 713.142857, MHz. • Press FREQ Channel, Chan Table, NTSC-J, NTSC-J AIR, and then press FREQ Channel, Channel, 53. 	<p>The first method is to enter the frequency directly.</p> <p>The second method is to set the frequency through channel table. Multiple channel tables are predefined in the instrument, including NTSC-M, NTSC-J, NTSC-Brazil, PAL-M, PAL-I, PAL-B/G, and PAL-D/K.</p> <p>You can change the definition of the channel table following the steps in “Customizing the Channel Table Definition” on page 19.</p>
5 Press Meas, Channel Power .	This selects the Channel Power measurement.
6 Press View/Display, RF Spectrum (default view).	This selects the RF Spectrum view.
7 View the RF Spectrum results.	<p>In the figure below, the graph window shows the spectrum trace and the text window shows the total power and PSD (power spectral density) level over 5.6 MHz band width.</p> <p>If the radio standard is set to ISDB-Tmm, the integration band width will be changed to 14.182 MHz automatically.</p> <p>To change the measurement integration band width manually, press Meas Setup, Integ BW.</p>

Step

Notes

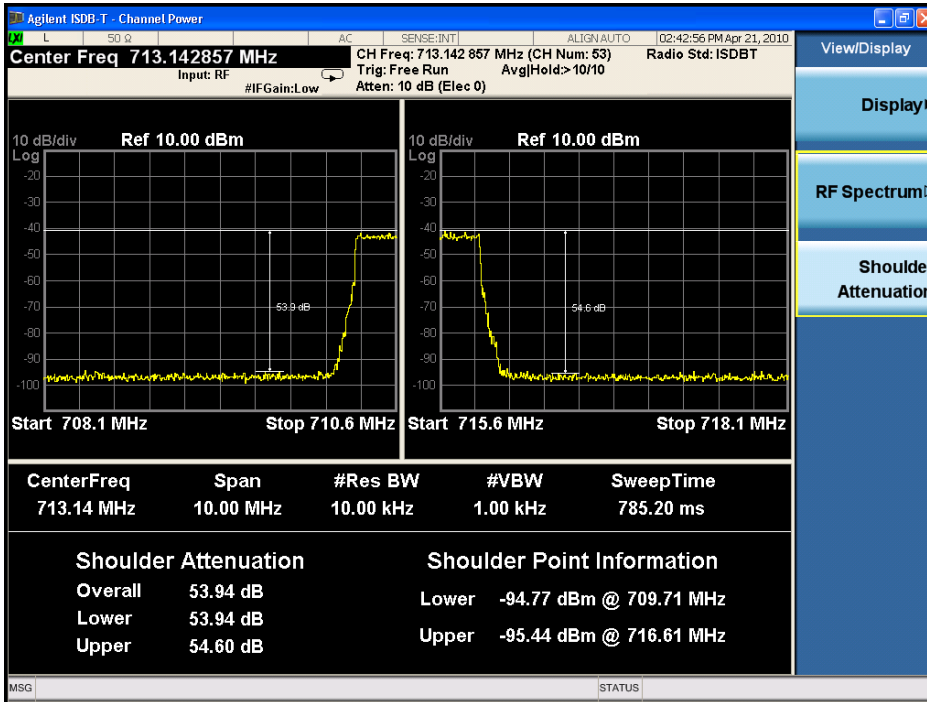

Customizing the Channel Table Definition

Channel table function enables you to specify the center frequency by entering the channel number under a specific channel table. In a channel table, each channel number corresponds to a center frequency. The predefined channel table complies with the industry standards.

A channel table file is used to export, edit, and then import the channel table settings so that you can customize the channel table to satisfy your measurement requirements.

The format of the channel table file is illustrated in Figure 2-2. The channel table file includes channel definitions for all the channel plans, such as NTSC-B, NTSC-J, NTSC-M, PAL-M, PAL-I, PAL-B/G, and PAL-D/K. Each channel plan is separated with a blank line.

File default location: My Documents\Digital Video\data

File type: text file

File extension: .txt

Figure 2-2 *Format of the Channel Table File*

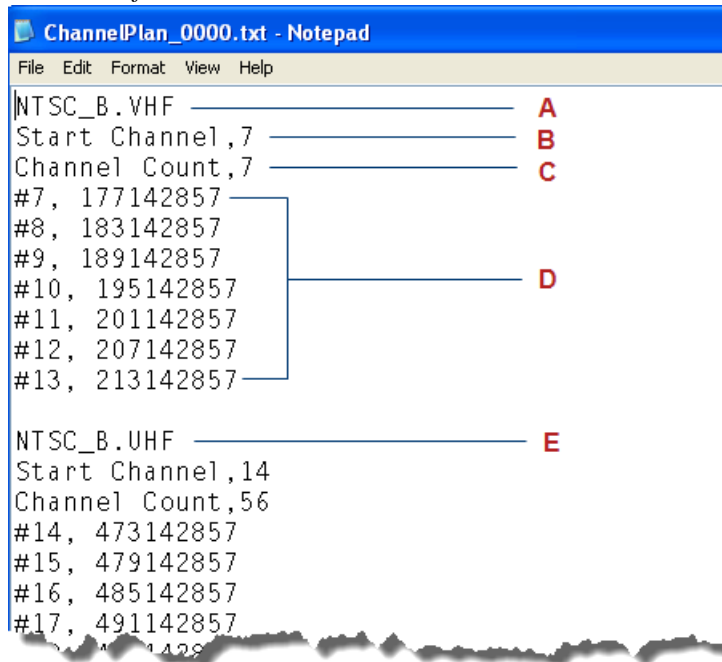

A. Channel plan name. This is the channel plan for NTSC-B VHF.

B. Start channel number. Here, the start channel number is 7.

C. Channel count in the current channel plan. There are 7 channels in the predefined NTSC-B VHF.

D. Channel number and corresponding center frequency, unit Hz. For example, #7, 177142857 means the center frequency for the channel 7 is 177142857 Hz.

E. The start of another channel plan NTSC-B UHF.

Perform following steps to customize the channel table:

Step	Notes
1 Press Save, Data, Channel Table , and then press Save As... , save the current channel table file as ChannelPlan_0000.txt (for example).	This saves the data of the current channel table into a file. You can save the file into the default directory "My Documents\Digital Video\data" or any other locations you like.

Step	Notes
<hr/> 2 Open the saved channel table file ChannelPlan_0000.txt, find the channel plan you are going to edit, and then make your desired changes.	<hr/> <p>You can add your own channel definitions to the channel table file, edit the center frequency value for the predefined channel, or remove the channel definitions unnecessary for your test.</p> <ul style="list-style-type: none"><li data-bbox="667 422 1406 667">• Adding channel definitions First, choose and find the channel plan you're going to edit on, for example, NTSC_B.VHF. Then, add the channel definitions including channel number and corresponding center frequency following the format "# channel number, center frequency". After that, edit the Start Channel and Channel Count values according to your changes.<li data-bbox="667 695 1406 804">• Editing the center frequency value for the channel Choose and find the channel plan you're going to edit, and then enter the center frequency value for the channel.<li data-bbox="667 831 1406 972">• Removing unnecessary channel definitions Choose and find the channel plan you're going to edit, and then delete the unnecessary channel definition. After that edit the Start Channel and Channel Count values. <p>Note that the name of the channel plan couldn't be changed. If it is changed, the modifications under this channel plan will not work and the default channel settings of the channel plan will work instead.</p>
<hr/> 3 Press Recall, Data, Channel Table , then press Open... , and open the channel table file you edited.	<hr/>
<hr/> 4 Press FREQ Channel to specify the center frequency under the new channel table.	<hr/> <p>If the instrument is restarted, the channel table file needs to be recalled again.</p>

ACP Measurements

This section describes the Adjacent Channel Leakage Power Ratio (ACLR or ACPR) measurement on an ISDB-T/Tsb/Tmm transmitter. ACPR is the measurement of the amount of interference or power, in adjacent frequency channels. The results are displayed as a bar graph or as spectrum data, with measurement data at specified offsets.

Step	Notes
1 Press Mode, ISDB-T .	
2 Press Mode Preset .	
3 Press Mode Setup, Radio Std, ISDB-T .	<p>This selects the radio standard for the signal under test. The standards available for selection under Radio Std menu depend on the licenses installed in your instrument:</p> <ul style="list-style-type: none">• If only N6155A-2FP (W6155A-2FP for CXA) is installed, two standards are available: ISDB-T and ISDB-Tsb.• If both N6155A-2FP (W6155A-2FP for CXA) and N6155A-3FP (W6155A-3FP for CXA) are installed, three standards are available: ISDB-T, ISDB-Tsb, and ISDB-Tmm. <p>Note that if the Radio Std is set to ISDB-Tmm, the center frequency is changed to 214.714286 MHz automatically as specified in the ISDB-Tmm standard.</p>
4 Do one of the following to set center frequency: <ul style="list-style-type: none">• Press FREQ Channel, Center Freq, 713.142857, MHz.• Press FREQ Channel, Chan Table, NTSC-J, NTSC-J AIR, and then press FREQ Channel, Channel, 53.	<p>The first method is to enter the frequency directly.</p> <p>The second method is to set the frequency through channel table. Multiple channel tables are predefined in the instrument, including NTSC-M, NTSC-J, NTSC-Brazil, PAL-M, PAL-I, PAL-B/G, and PAL-D/K.</p> <p>You can change the definition of the channel table following the steps in “Customizing the Channel Table Definition” on page 19.</p>
5 Press Meas, ACP .	
6 Press Meas Setup, More 1 of 2, Noise Correction and toggle it to On .	<p>This operation can reduce the noise levels and improve the ACP measurement results.</p>

Step

Notes

7 View the ACP measurement results.

See the figure below for the ACP results of the ISDB-T transmitter. The graph window shows the bar graph with the spectrum trace overlay. The text window shows the total power in the reference channel, the absolute and relative power in the offset channels.

If you are making ACP measurements on ISDB-Tsb/Tmm signal, press **Meas Setup** and set the carrier and offset/limits parameters under **Carrier Setup** and **Offset/Limits** menu as needed. No ACP measurement methods are defined in ISDB-Tsb/Tmm specifications.

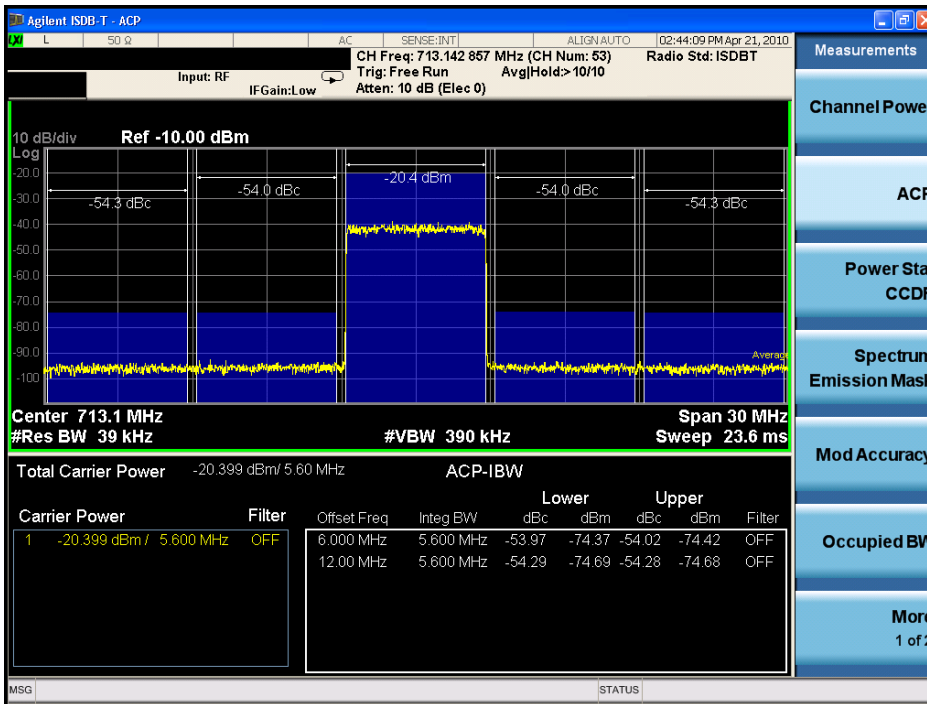

Power Stat CCDF Measurements

This section outlines how to make the Power Statistics Complementary Cumulative Distribution Function (Power Stat CCDF) measurement on an ISDB-T/Tsb/Tmm transmitter. Power Stat CCDF measurements characterize the higher level power statistics of a digitally modulated signal.

Power Statistics CCDF measurements can also be used to measure the BBIQ (Baseband I/Q) signals. For the detailed measurement procedure, refer to [“Using Option BBA Baseband I/Q Inputs” on page 73](#).

Step	Notes
1 Press Mode, ISDB-T .	
2 Press Mode Preset .	
3 Press Mode Setup, Radio Std, ISDB-T .	<p>This selects the radio standard for the signal under test. The standards available for selection under Radio Std menu depend on the licenses installed in your instrument:</p> <ul style="list-style-type: none"> ▪ If only N6155A-2FP (W6155A-2FP for CXA) is installed, two standards are available: ISDB-T and ISDB-Tsb. ▪ If both N6155A-2FP (W6155A-2FP for CXA) and N6155A-3FP (W6155A-3FP for CXA) are installed, three standards are available: ISDB-T, ISDB-Tsb, and ISDB-Tmm. <p>Note that if the Radio Std is set to ISDB-Tmm, the center frequency is changed to 214.714286 MHz automatically as specified in the ISDB-Tmm standard.</p>
<p>4 Do one of the following to set center frequency:</p> <ul style="list-style-type: none"> ▪ Press FREQ Channel, Center Freq, 713.142857, MHz. ▪ Press FREQ Channel, Chan Table, NTSC-J, NTSC-J AIR, and then press FREQ Channel, Channel, 53. 	<p>The first method is to enter the frequency directly.</p> <p>The second method is to set the frequency through channel table. Multiple channel tables are predefined in the instrument, including NTSC-M, NTSC-J, NTSC-Brazil, PAL-M, PAL-I, PAL-B/G, and PAL-D/K.</p> <p>You can change the definition of the channel table following the steps in “Customizing the Channel Table Definition” on page 19.</p>
5 Press Power Stat CCDF .	

Step

Notes

6 View the Power Stat CCDF measurement results.

In the figure below, the statistic data of the peak to average ratio is listed in the text window.

In the graph window, the blue line is the Gaussian trace and the yellow line is the measurement result. The Info BW is the channel band width that will be used for data acquisition. The default value is 6 MHz.

To measure the Power Stat CCDF results on ISDB-Tsb or ISDB-Tmm signals, you need to manually change the Info BW by pressing **BW**, **Info BW**. The entered value should be higher than the band width of the signal.

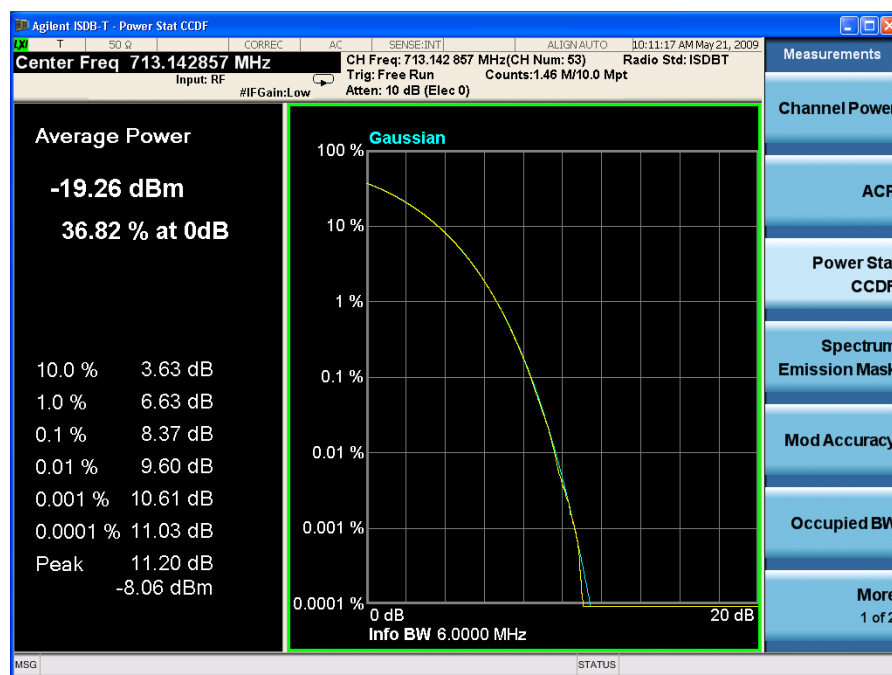

7 Press **Trace/Detector, Ref Trace (On)** to display the user-definable reference trace (violet line).

The reference trace is a measurement trace stored as a reference trace to be compared to a later measurement. You can use the **Store Ref Trace** key to save the currently measured trace as the reference trace. This reference trace will be lost if you switch between modes or measurements.

Step

Notes

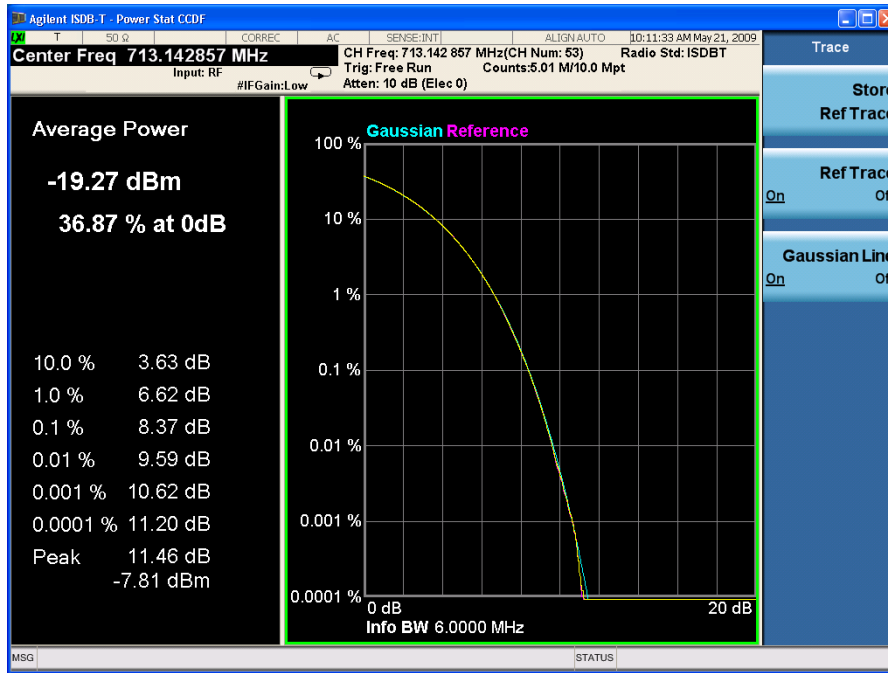

Troubleshooting Hints

The Power Stat CCDF measurement is useful in defining the signal power specifications for design criteria for systems, amplifiers, and other components. When the signal power is larger than the limit of the mixer or ADC, the CCDF result trace will deviate from the Gaussian trace.

Spectrum Emission Mask Measurements

This section describes how to make the Spectrum Emission Mask (SEM) measurements on an ISDB-T/Tsb/Tmm transmitter. SEM measurements compare the power levels within given offset channels on both sides of the carrier frequency, to the power levels allowed by the standard when there are digital TV signals or other services in adjacent channels.

Step	Notes
1 Press Mode, ISDB-T .	
2 Press Mode Preset .	
3 Press Mode Setup, Radio Std, ISDB-T .	<p>This selects the radio standard for the signal under test. The standards available for selection under Radio Std menu depend on the licenses installed in your instrument:</p> <ul style="list-style-type: none"> ▪ If only N6155A-2FP (W6155A-2FP for CXA) is installed, two standards are available: ISDB-T and ISDB-Tsb. ▪ If both N6155A-3FP (W6155A-3FP for CXA) and N6155A-3FP (W6155A-3FP for CXA) are installed, three standards are available: ISDB-T, ISDB-Tsb, and ISDB-Tmm. <p>Note that if the Radio Std is set to ISDB-Tmm, the center frequency is changed to 214.714286 MHz automatically as specified in the ISDB-Tmm standard.</p>
<p>4 Do one of the following to set center frequency:</p> <ul style="list-style-type: none"> ▪ Press FREQ Channel, Center Freq, 713.142857, MHz. ▪ Press FREQ Channel, Chan Table, NTSC-J, NTSC-J AIR, and then press FREQ Channel, Channel, 53. 	<p>The first method is to enter the frequency directly.</p> <p>The second method is to set the frequency through channel table. Multiple channel tables are predefined in the instrument, including NTSC-M, NTSC-J, NTSC-Brazil, PAL-M, PAL-I, PAL-B/G, and PAL-D/K.</p> <p>You can change the definition of the channel table following the steps in “Customizing the Channel Table Definition” on page 19.</p>
5 Press Spectrum Emission Mask .	This selects the Spectrum Emission Mask measurement.
6 Press Input/Output, External Gain, Ext Preamp, -60, dB .	This sets the value for the external attenuator to get the actual transmitting power of the transmitter under test.

Step	Notes
<p>7 Press Input/Output, More 1 of 2, Corrections, toggle the Correction key to On, and then do one of the following to specify correction data:</p> <ul style="list-style-type: none"> • Press Edit and enter the frequency and amplitude data. • Press Recall, Data (Import) Amptd Cor1, Open to import the correction file. 	<p>This applies amplitude correction.</p> <p>To get the format of the file to be recalled, first edit several points using onscreen editor, then press Save, Data (Export) Correction 1, Save As... to save the correction data to a file. Open the file, and view the format.</p> <p>For more detailed information regarding amplitude correction and the definition of correction data, refer to “Amplitude Correction in Spectrum Emission Mask Measurement” on page 94.</p>
<p>8 Press Meas Setup, Limit Type, JEITA, Auto Sense.</p>	<p>This applies the spectrum mask defined in ARIB STD B31.</p> <p>Actually, there are six limit types available, as follows. For more information regarding their definitions, refer to “Spectrum Emission Limits Defined by Standard” on page 90.</p> <ul style="list-style-type: none"> • Manual: Specify the spectrum mask manually by setting parameters under Meas Setup, Ref Channel and Meas Setup, Offset/Limit. To measure the spectrum mask on ISDB-Tmm signals, you need to use the Manual method to specify the spectrum mask. • JEITA: Spectrum mask for ISDB-T defined in Japan ARIB STD B31. There are four option under JEITA, which are Auto Sense, 30dB Mask, 40dB Mask, and 50dB Mask. To compliant with ARIB-STD B31 Version 1.7 while using JEITA limit type, choose the appropriate option under JEITA according to your measurement environment as listed in Table 2-3. • ABNT Non-Critical: Spectrum mask for non-critical case defined in Brazil ABNT NBR 15601. • ABNT Sub-Critical: Spectrum mask for sub-critical case defined in Brazil ABNT NBR 15601. • ABNT Critical: Spectrum mask for critical case defined in Brazil ABNT NBR 15601. • ISDB-Tsb: Spectrum mask for ISDB-Tsb in ARIB STD B29.
<p>9 View the Spectrum Emission Mask measurement results.</p>	<p>In the figure below, the top window shows the measured trace together with the limit mask and the bottom window lists the related parameters.</p> <p>You can zoom on either the graphic window or the text window by pressing the Window Control keys  at the left bottom of the front panel.</p>

Step

Notes

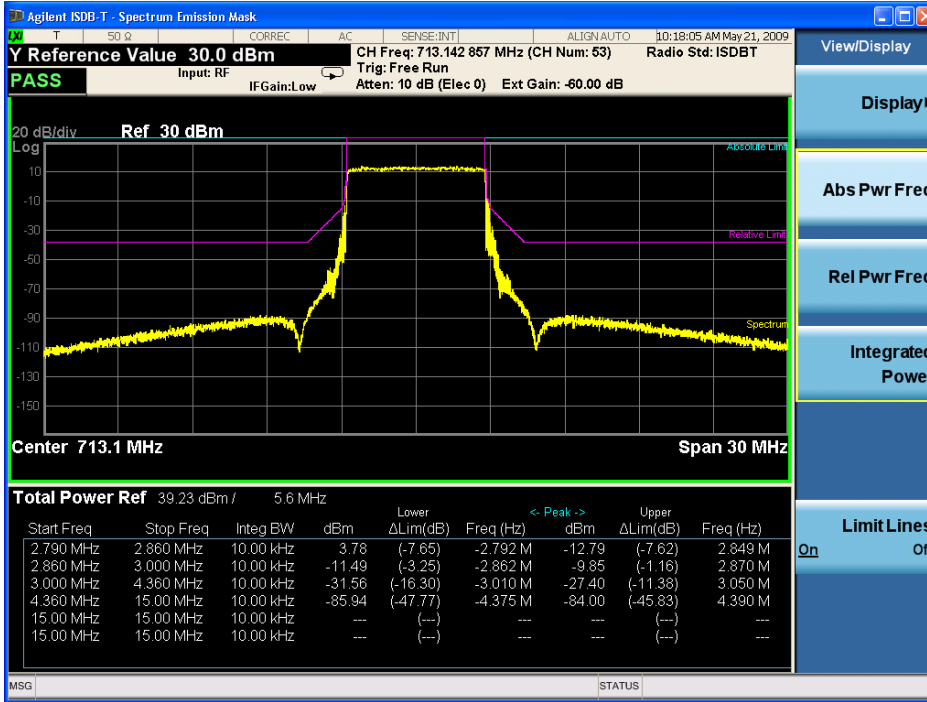

Table 2-3 Actions to Compliant with ARIB-STD B31 Version 1.7 Using JEITA Limit

Channel Power P	Is adjacent channels used for analog TV?	Is the analog TV has more than or equal to 10 times higher than the channel power?	Offset D limit ($\pm(4.36\sim 15)$ MHz) from carrier frequency)	Mask under JEITA to be used
$P > 2.5W$	Yes/No	Yes/No	-77.4 dB/10kHz	Auto Sense
$2.5W \geq P > 0.25W$	No	None	-73.4-10logP [dB/10kHz]	Auto Sense
	Yes	Yes	-73.4-10logP [dB/10kHz]	Auto Sense
	Yes	No	-77.4 dB/10kHz	50dB Mask
$0.25W \geq P > 0.025W$	No	None	-73.4-10logP [dB/10kHz]	Auto Sense
	Yes	Yes	-67.4 dB/10kHz	40dB Mask
	Yes	No	-77.4 dB/10kHz	50dB Mask

Table 2-3 Actions to Compliant with ARIB-STD B31 Version 1.7 Using JEITA Limit

Channel Power P	Is adjacent channels used for analog TV?	Is the analog TV has more than or equal to 10 times higher than the channel power?	Offset D limit ($\pm(4.36\sim15)$ MHz) from carrier frequency)	Mask under JEITA to be used
$0.025 W \geq P$	No	None	-57.4 dB/10kHz	Auto Sense
	Yes	Yes	-67.4 dB/10kHz	40 dB Mask
	Yes	No	-77.4 dB/10kHz	50dB Mask

Troubleshooting Hints

The Spectrum Emission Mask measurement can reveal degraded or defective parts in the transmitter section of the unit under test (UUT). The following are examples of typical causes for poor performance:

- Faulty DC power supply control of the transmitter power amplifier.
- RF power controller of the pre-power amplifier stage.
- I/Q control of the baseband stage.
- Degradation in the gain and output power level of the amplifier may be due to degraded gain control or increased distortion, or both.
- Degradation of the amplifier linearity or other performance characteristics.

Power amplifiers are one of the final stage elements of an ISDB-T/Tsb transmitter and are a critical part of meeting the important power and spectral efficiency specifications. Since Spectrum Emission Mask measures the spectral response of the amplifier to a complex wideband signal, SEM is a key measurement linking amplifier linearity and other performance characteristics to the stringent system specifications.

Modulation Accuracy Measurements

This section describes how to make a Modulation Accuracy measurement on an ISDB-T/Tsb/Tmm transmitter. Modulation Accuracy measurements provide methods for measuring the I/Q errors in ISDB-T/Tsb/Tmm transmitter. The results comprise EVM, MER, magnitude error, phase error, frequency error, quad error, amplitude imbalance, TMCC decoding results, etc.

Mod Accuracy measurements can be used to measure BBIQ (Baseband I/Q) signals. For the detailed measurement procedure, refer to [“Using Option BBA Baseband I/Q Inputs” on page 73](#).

The measurement procedure for ISDB-T/Tsb signals and ISDB-Tmm signals are different and introduced separately as below:

- [“Making Modulation Accuracy Measurements on ISDB-T/Tsb Signals” on page 31](#)
- [“Making Modulation Accuracy Measurements on ISDB-Tmm Signals” on page 44](#)

Making Modulation Accuracy Measurements on ISDB-T/Tsb Signals

The modulation parameters of the ISDB-T signal under test is as below:

Center frequency: 713.142857 MHz

Radio standard: ISDB-T

Mode: Mode 3

Bandwidth: 6 MHz

Guard interval: 1/8

Partial reception: On

Layer A settings: 1 segment; code rate = 1/2; QPSK

Layer B settings: 4 segment; code rate = 3/4; 64QAM

Layer C settings: 8 segment; code rate = 2/3; 16QAM

Step	Notes
1	Press Mode , ISDB-T .
2	Press Mode Preset .

Making ISDB-T/Tsb/Tmm Measurements
ISDB-T/Tsb/Tmm Transmitter Measurements

Step	Notes
<p>3 Do one of the following to set center frequency:</p> <ul style="list-style-type: none">• Press FREQ Channel, Center Freq, 713.142857, MHz.• Press FREQ Channel, Chan Table, NTSC-J, NTSC-J AIR, and then press FREQ Channel, Channel, 53.	<p>The first method is to enter the frequency directly.</p> <p>The second method is to set the frequency through channel table. Multiple channel tables are predefined in the instrument, including NTSC-M, NTSC-J, NTSC-Brazil, PAL-M, PAL-I, PAL-B/G, and PAL-D/K.</p> <p>You can change the definition of the channel table following the steps in “Customizing the Channel Table Definition” on page 19.</p>
<p>4 Press Mode Setup, Radio Std, ISDB-T.</p>	<p>This selects the radio standard for the signal under test. The standards available for selection under Radio Std menu depend on the licenses installed in your instrument:</p> <ul style="list-style-type: none">• If only N6155A-2FP (W6155A-2FP for CXA) is installed, two standards are available: ISDB-T and ISDB-Tsb.• If both N6155A-2FP (W6155A-2FP for CXA) and N6155A-3FP (W6155A-3FP for CXA) are installed, three standards are available: ISDB-T, ISDB-Tsb, and ISDB-Tmm.
<p>5 Press Meas, Mod Accuracy.</p>	<p>This selects the modulation accuracy measurement.</p>
<p>6 If the Radio Std is set to ISDB-T, press Mode Setup, Channel BW, 6 MHz.</p>	<p>This sets the channel band width according to the signal under test.</p>

Step	Notes
7 Press Meas Setup, Auto Detect .	<p>This is to use the auto-detect function to set demodulation parameters, which detect the modulation parameters from the TMCC information of the input signal.</p> <p>IMPORTANT Before performing auto-detection, make sure the signal is valid and the following parameters are set correctly: Channel BW (under Mode Setup menu) for ISDB-T signals; Segment Num and Center Sub-channel (under Mode Setup, Radio Std, ISDB-Tsb menu) for ISDB-Tsb signals.</p> <p>The demodulation parameters can also be set manually as below. Note that Mode Setup menu structure, where the keys below are located, is changed dramatically to support the ISDB-Tmm measurement in the A.08.xx revision (you can check the revision number by pressing System, Show, System on the instrument).</p> <ol style="list-style-type: none">a. Press Mode Setup, Radio Std, ISDB-T, press ISDB-T again. After that,<ul style="list-style-type: none">• Toggle Partial Reception key to On.• Press Layer A, Modulation Format, QPSK.• Press Layer B, Segment Count, 4, Modulation Format, 64 QAM.• Press Layer C, Modulation Format, 16QAM.b. Press Mode Setup, Radio Std, Common, and then press Mode, Mode 3, Guard Interval, 1/8.
NOTE	<p>The following steps are to view the measurement results in different views. These steps don't have to be taken in sequence. Click on the link of any view below to learn the steps to view the results for a specific view directly. You can zoom on either the graphic window or the text window in each view by pressing the Window Control keys  at the left bottom of the frontpanel.</p> <ul style="list-style-type: none">• IQ Measured Polar Graph view on page 34• IQ Error view on page 34• Channel Frequency Response view on page 35• Channel Impulse Response view on page 36• Spectral Flatness view on page 37• TMCC Decoding view on page 38• AC Decoding view on page 39• MER vs. Segment view on page 40<ul style="list-style-type: none">• Result Metrics view on page 40

Step	Notes
8 Press View/Display, IQ Measured Polar Graph.	
9 View the I/Q measured polar graph results.	<p>The constellation graph is shown in the graphic window. The blue points are data points and the white points are pilot or TMCC points. EVM, MER, magnitude error, phase error, frequency error, and Tx power results are shown in the text window.</p> <p>To view the constellation results in specified carrier ranges, press I/Q Measure Polar Graph again, and set values for the Start Carrier and Stop Carrier.</p>

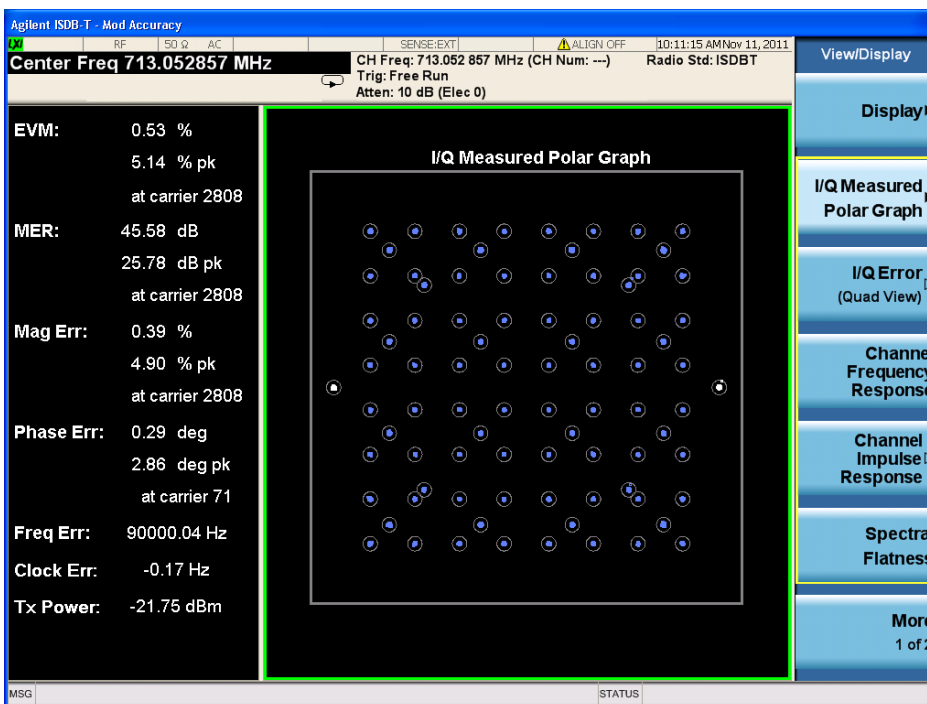

10 Press View/Display, I/Q Error.	This selects the I/Q error view.
11 Press I/Q Error again, then press Display Type , select Layer , and press Layer , select Layer B .	<p>This is an example of setting Layer B as the data to display.</p> <p>Actually, for ISDB-T/Tsb signals, three display types are available, which enable you to view the measurement results on each layer or segment.</p> <p>To view the results for segment 8 (example), select Segment as Display Type, and press Segment Index, 8.</p> <p>To view the results for a frame, press Display Type, All.</p>

Step

Notes

12 View the I/Q error results.

Four windows are displayed in the I/Q Error results as below.

- MER\EVM vs. Subcarrier\Frequency window (top-left): MER or EVM on each subcarrier or frequency calculated using the data from the whole frame.

You can change the scale type for the vertical axis and the horizontal axis by setting the **Scale Type** key under **AMPTD Y Scale** and **Span X Scale** menu.

- Segment Map window (top-right)
- DataSegment/Layer Polar Graph window (bottom-left)
- Result window (bottom-right): a summary of results calculated using the selected display data.

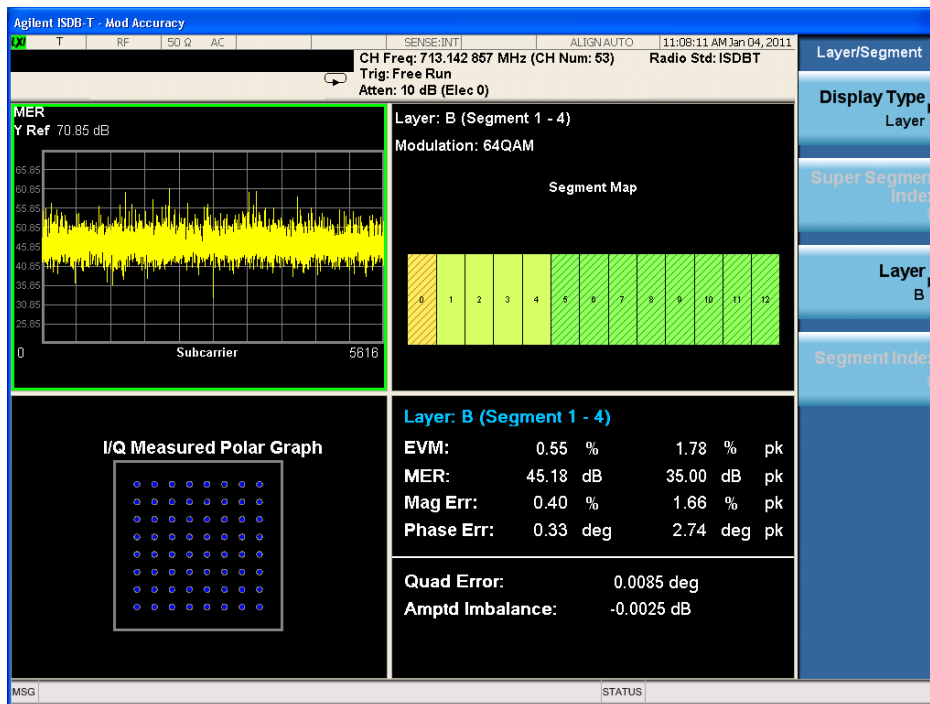

13 Press **View/Display, Channel Frequency Response**.

This selects the channel frequency response view.

If the currently selected window is the first window, amplitude vs. subcarrier window, you can use the normalize function under Trace/Detector, Normalize menu to measure the frequency response of a device, such as an amplifier or attenuator. For more information, refer to [“Using Normalize Function in Channel Frequency Response View”](#) on page 41.

Making ISDB-T/Tsb/Tmm Measurements

ISDB-T/Tsb/Tmm Transmitter Measurements

Step

Notes

14 View the channel frequency response results.

The figure below displays the amplitude, phase, and group delay results on every subcarrier. The Pk to Pk value displayed on the top of each window is the difference between the maximum value and the minimum value in the current window.

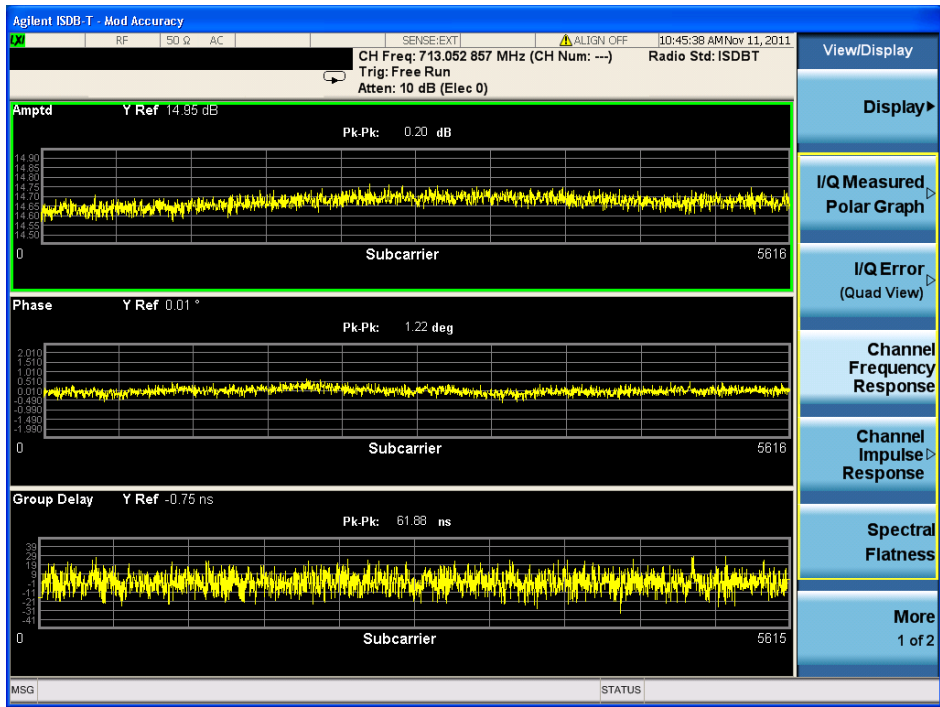

15 Press **View/Display, Channel Impulse Response**, and then press **Meas Setup, Advanced, toggle Equalization to On**.

This selects the channel impulse response view, and turns on the equalizer. Turning the equalizer On can gain better channel impulse response results.

Step

Notes

16 View the channel impulse response results.

The graphic window shows the channel impulse response trace and the peak table window shows the delay and amplitude of the top 10 peaks on the trace at most.

The blue bar with the range of GI indicates that all the paths included are used to reconstruct the signal for measurement. The position of the blue bar will be changed with the FFT Start Position (under Meas Setup, Advanced panel) value. Refer to [“SFN Reception Conditions and FFT Start Position”](#) on page 99 for more information.

The green line with -35 dB above its right side is the peak limit line, which means only peaks above this line can be displayed in the peak table. To adjust the peak limit line, press **Peak Search, More 1 of 2, Peak Table**, and then enter your desired peak limit value.

Peak table window is very useful when there are more than one path in the channel. For more information, refer to [“Peak Table”](#) on page 101.

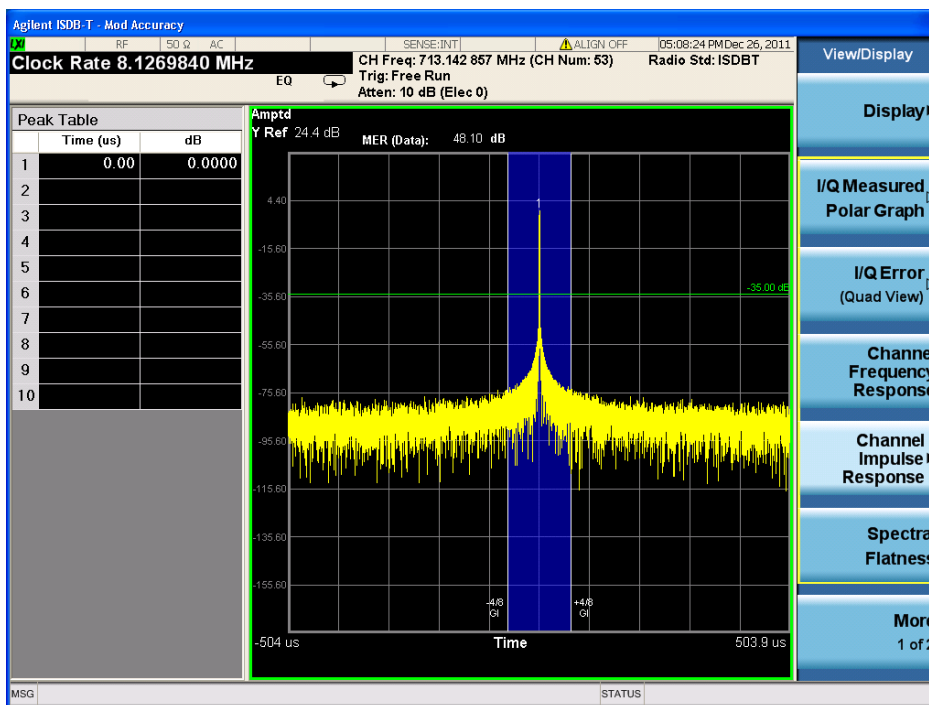

17 Press **View/Display, Spectral Flatness**.

This selects the spectral flatness view.

18 View the spectral flatness results.

The figure below displays the inband spectrum ripple.

Making ISDB-T/Tsb/Tmm Measurements
 ISDB-T/Tsb/Tmm Transmitter Measurements

Step

Notes

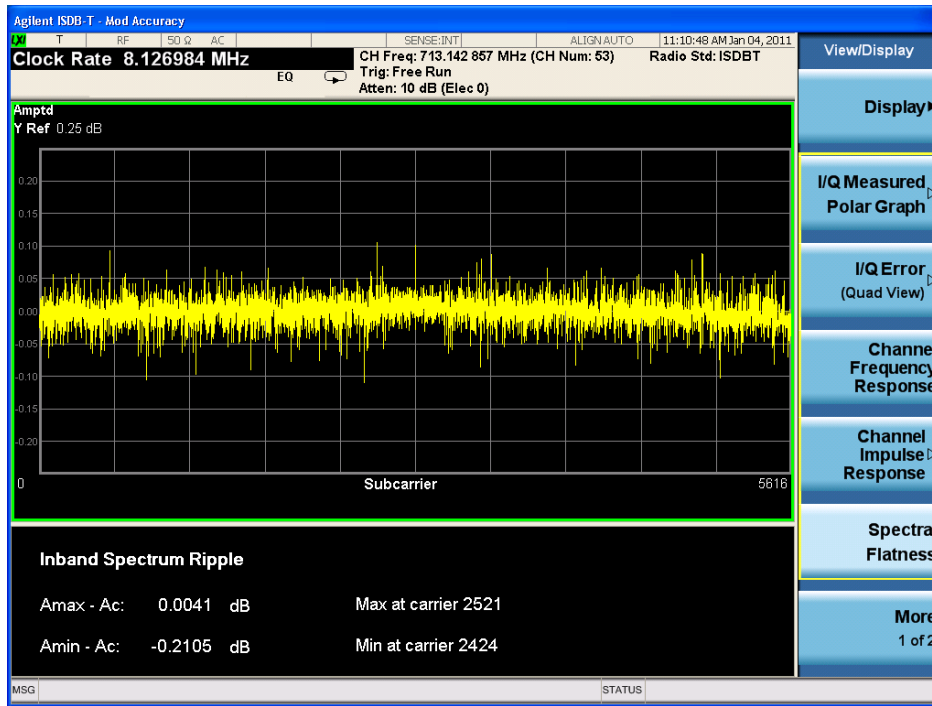

19 Press **View/Display, More 1 of 2, TMCC Decoding.**

This selects the TMCC decoding view.

20 View the TMCC decoding results.

The figure below displays the information decoded from TMCC. The results in yellow with the title "Current" show the current hierarchical configuration and transmission parameters, while the results in purple with the title "Next" show the information for the next hierarchical. The results in white in the rightmost column indicate the current settings under **Mode Setup, Demod.**

Step **Notes**

NOTE The **ISDB-Tmm Config** view is only used for ISDB-Tmm signals, providing the configuration information of the ISDB-Tmm signal. If the current signal under test is ISDB-T or ISDB-Tsb signal, an error message "No Result; Not supported in T/Tsb" will be displayed in the right bottom of the screen.

23 Press **View/Display, More 1 of 2, MER vs. Segment.** This is to view the MER of each segment.

24 View the MER vs. Segment results. The graphic below displays the MER result of each segment. The segment indexes 13 ~ 32 are designed for ISDB-Tmm signals, which contains up to 33 segments, so the MER results for these indexes are all displayed as "---".

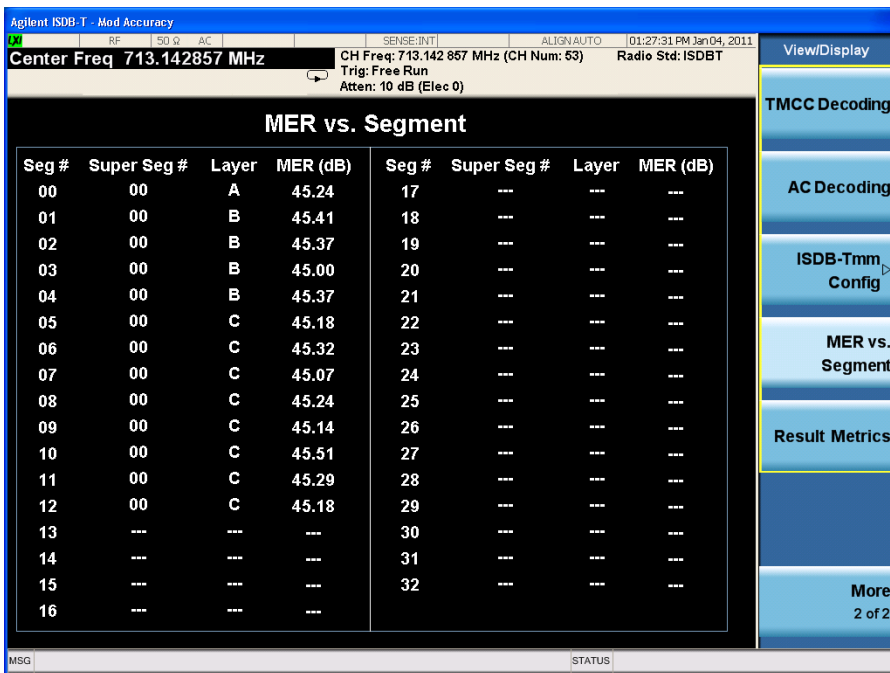

25 Press **View/Display, More 1 of 2, Result Metrics.** This selects the result metrics view.

26 View the summary of the results. This view is a summary of the modulation accuracy measurement results.

You can check the MER results calculated using all the subcarriers, layer A/B/C, data, pilot, TMCC, and AC1 in the Result Metrics view. For more information of calculating MER, refer to "MER Measurement Method" on page 96.

Step

Notes

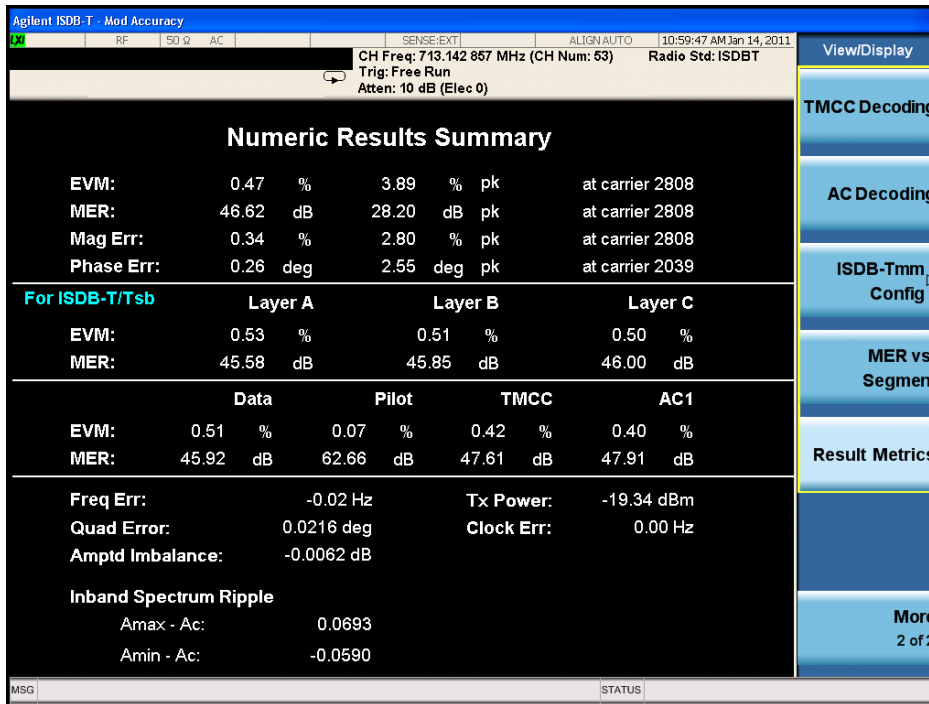

Using Normalize Function in Channel Frequency Response View

Normalize function in channel frequency response view can be used to measure the frequency response of a device, such as an amplifier or attenuator. Here, take an attenuator as an example. The detailed procedure is as below.

NOTE

To avoid duplication, this section only lists actions directly related to normalize function. For information about how to make channel impulse response measurements, you can refer to the measurement procedures.

1. Connect the signal source directly to the signal analyzer to get the frequency response of the test system. In channel frequency response view, press the zoom window key  to zoom in the amplitude vs. subcarrier window.
2. Press **Trace/Detector, Normalize, Store Ref** to store the current measurement result as reference (TraceRef), as in [Figure 2-3](#).

Figure 2-3 Reference Trace



3. Connect the device under test between the signal source and the signal analyzer. The measured amplitude vs. subcarrier trace in the channel frequency response view (Tracemeas) is show in [Figure 2-4](#).

After the device is connected, if the input power level changes a lot, you may need to adjust the value of attenuator or turn on the preamplifier using keys under AMPTD Y Scale menu.

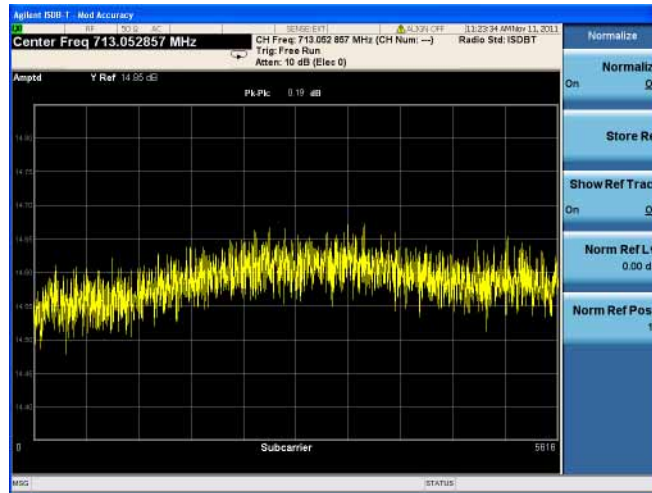
Figure 2-4 Amplitude vs. Subcarriers Trace after Connecting the Device

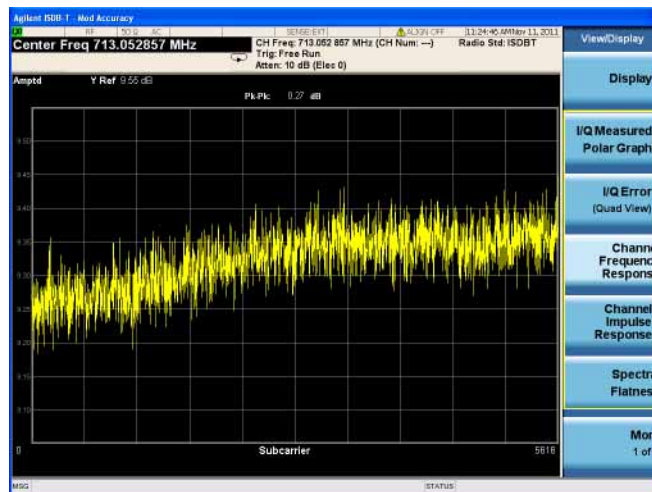

4. Press **Trace/Detector**, **Normalize**, and toggle **Normalize** to **On**, and set **Norm Ref Posn** to **5**. The displayed trace (TraceNorm), as in [Figure 2-5](#), is the frequency response of the device under test, which is calculated by Tracemeas - TraceRef.

Figure 2-5 Normalized Trace (Frequency Response of the Device)

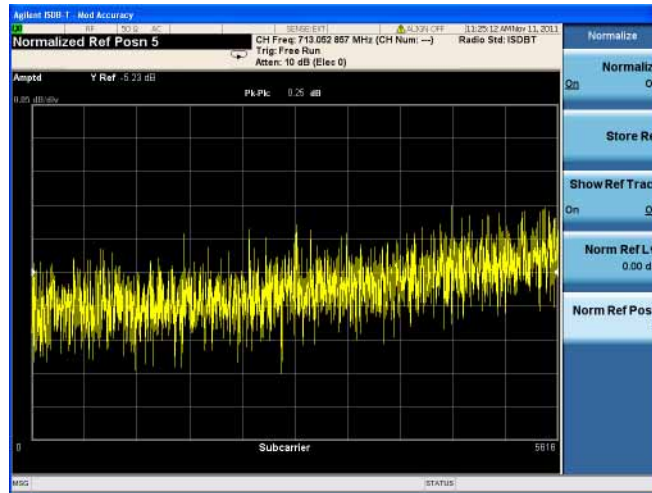

5. (Optional) Press **Trace/Detector**, **Normalize** and toggle **Show Ref Trace** to **On** to show the stored reference trace. You may need to adjust the Ref Value and Scale/Div under AMPTD Y Scale menu to display both the Normalized trace and the reference trace.

NOTE

To place a Marker on the different traces of the various views, press **Marker**, **Properties**, **Marker Trace**, then select the trace you want to put the marker on. There are 6 traces to select from: Polar Trace, MER/EVM vs.Carr/Freq, Amptd vs.Carr, Phase vs.Carr, GD vs.Carr, Amptd vs.Time.

Making Modulation Accuracy Measurements on ISDB-Tmm Signals

The modulation parameters of the ISDB-Tmm signal under test are as below. This configuration is compliant with the configuration A defined in the ISDB-Tmm operational guideline:

Central frequency: 214.714286 MHz

Mode: Mode3

GI: 1/4

The frame configuration is as below:

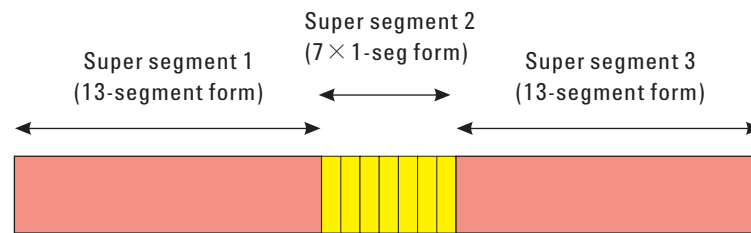

Super segment 1 and super segment 3 settings:

Super segment type: Type A

Partial Reception: On

Layer A: 1 segment; QPSK

Layer B: 12 segment; 16QAM

Super segment 2 settings:

Super segment type: Type B

1-segment number: 7

Center sub-channel for each segment: 1, 4, 7, 10, 13, 16, 19

Modulation format for each segment: all QPSK

Step	Notes
1 Press Mode , ISDB-T .	
2 Press Mode Preset .	
3 Press Mode Setup , Radio Std , ISDB-Tmm .	<p>This selects the radio standard for the signal under test. The standards available for selection under Radio Std menu depend on the licenses installed in your instrument:</p> <ul style="list-style-type: none">• If only N6155A-2FP (W6155A-2FP for CXA) is installed, two standards are available: ISDB-T and ISDB-Tsb.• If both N6155A-2FP (W6155A-2FP for CXA) and N6155A-3FP (W6155A-3FP for CXA) are installed, three standards are available: ISDB-T, ISDB-Tsb, and ISDB-Tmm. <p>To make measurements on ISDB-Tmm signals, you need to make sure the N6155A-3FP (W6155A-3FP for CXA) license is installed in your instrument.</p>
4 Press FREQ Channel , Center Freq , 214.714286, MHz .	<p>Note that the center frequency is changed to 214.714286 MHz automatically as specified in the ISDB-Tmm standard when the radio std is set to ISDB-Tmm. If you are using a different center frequency, remember to set it manually.</p>
5 Press Meas , Mod Accuracy .	<p>This selects the modulation accuracy measurement.</p>
6 If the modulation parameters of the signal under test are not the same with the default settings (see the configuration of the example signal on page 44), you need to create a new ISDB-Tmm configuration file for the current ISDB-Tmm signal and then import it into the instrument by pressing Recall , Data , ISDB-Tmm Config , and then Opening... to select the configuration file.	<p>The default settings are compliant with the configuration A defined in the operation guideline. The configuration file of the default settings, named as "ISDBTmmConfig_Demo.csv", can be found in the directory, "D:\User_My_Documents\Instrument\My Documents\ISDBT\data\EVM".</p> <p>To create the configuration file, refer to “Creating ISDB-Tmm Configuration File” on page 54.</p>

Step	Notes
NOTE	The following steps are to view the measurement results for different views. These steps don't have to be taken in sequence. Click on the link of any view below to learn the steps to view the results for a specific view directly.
<ul style="list-style-type: none">▪ IQ Measured Polar Graph view on page 46▪ IQ Error view on page 47▪ Channel Frequency Response view on page 48▪ Channel Impulse Response view on page 49▪ Spectral Flatness view on page 50▪ ISDB-Tmm Config view on page 51▪ MER vs. Segment view on page 52<ul style="list-style-type: none">▪ Result Metrics view on page 53	
7 Press View/Display, I/Q Measured Polar Graph .	This selects the I/Q measured polar graph view, which is the default view.
8 View the I/Q measured polar graph results.	The constellation graph is shown in the graphic window. The blue points are data points and the white points are pilot or TMCC points. EVM, MER, magnitude error, phase error, frequency error, and Tx power results are shown in the text window. To view the constellation results in specified carrier ranges, press I/Q Measure Polar Graph again, and set values for the Start Carrier and Stop Carrier .

Step

Notes

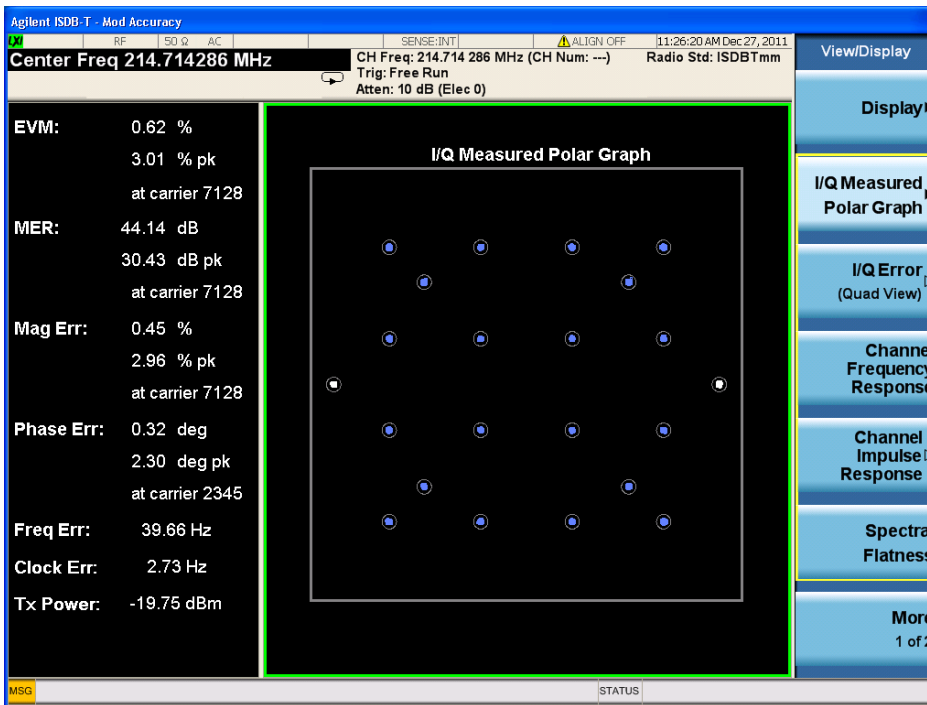

9 Press View/Display, I/Q Error.

This selects the I/Q error view.

10 Press **I/Q Error** again, then press **Display Type, All**.

This sets to display all the carriers in the ISDB-Tmm signals in the I/Q error view.

In this view, three display types are available to view the results for each super segment or segment of the ISDB-Tmm signal. If the selected super segment is type A, you can also select to view the results for each layer in it.

To view layer A in super segment 0 (example):

- Press **Display Type, Super Segment**.
- Press **Super Segment Index, 0**.
- Press **Layer, Layer A**.

To view segment 22 (example):

- Press **Display Type, Segment**.
- Press **Segment Index, 22**.

Step

Notes

11 View the IQ Error results.

Four windows are displayed in the I/Q Error results as below:

- MER\EVM vs. Subcarrier\Frequency window (top-left): MER or EVM on each subcarrier or frequency.
 To change the scale type for the vertical axis or the horizontal axis, press **AMPTD Y Scale** or **Span X Scale, Scale Type**.
- Segment Map window (top-right): shows the super segment structure of the Tmm signal under test and illustrates the part of data currently viewed.
- Constellation graph (bottom-left): the constellation graph for specified data.
- Result window (bottom-right): results calculated using specified data.

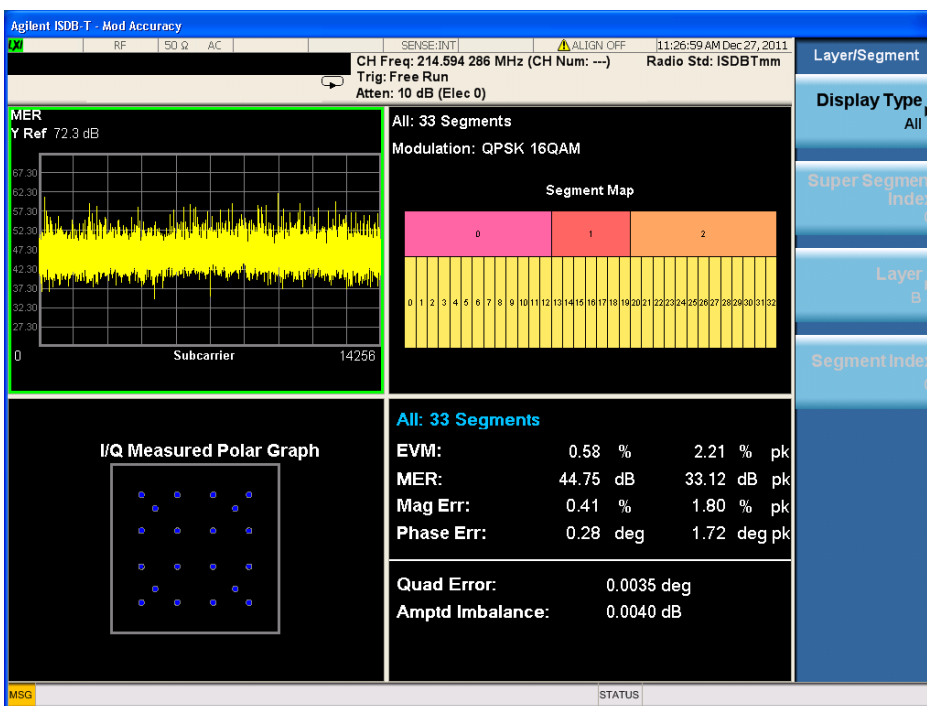

12 Press **View/Display, Channel Frequency Response**.

This selects the channel frequency response view.

If the currently selected window is the first window, amplitude vs. subcarrier window, you can use the normalize function under Trace/Detector, Normalize menu to measure the frequency response of a device, such as an amplifier or attenuator. For more information, refer to [“Using Normalize Function in Channel Frequency Response View”](#) on page 41.

Step

Notes

13 View the channel frequency response results.

The figure below displays the amplitude, phase, and group delay results on every subcarrier. The Pk to Pk value displayed on the top of each window is the difference between the maximum value and the minimum value in the current window.

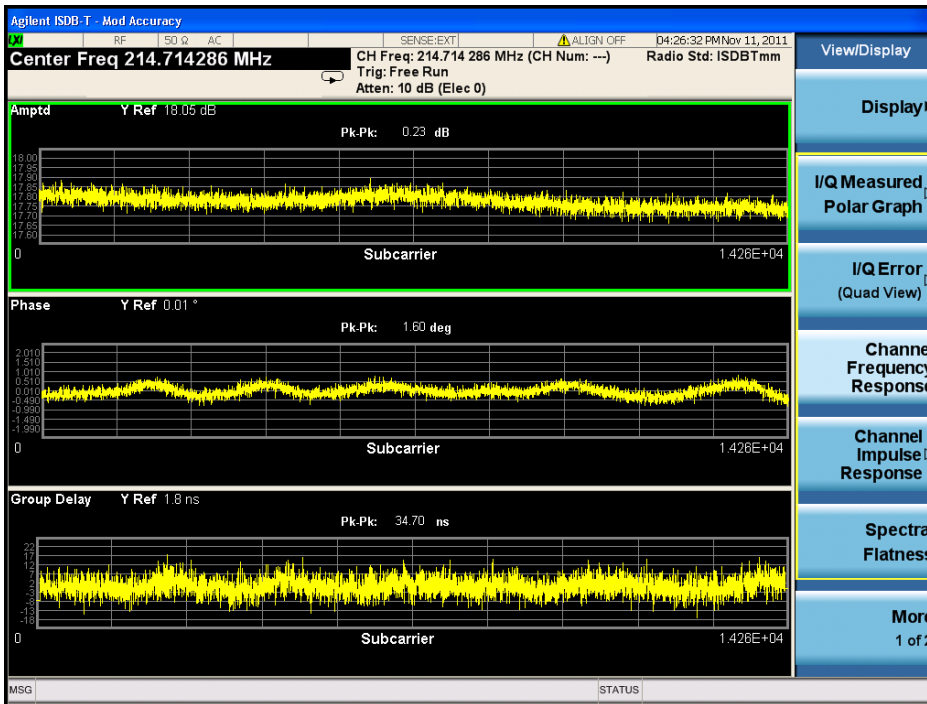

14 Press **View/Display, Channel Impulse Response**, and then press **Meas Setup, Advanced, toggle Equalization to On**.

This selects the channel impulse response view, and turns on the equalizer. Turning the equalizer On can gain better channel impulse response results.

Step

Notes

15 View the channel impulse response results.

The graphic window shows the channel impulse response trace and the peak table window shows the delay and amplitude of the top 10 peaks on the trace at most.

The blue bar with the range of GI indicates that all the paths included are used to reconstruct the signal for measurement. The position of the blue bar will be changed with the FFT Start Position (under Meas Setup, Advanced panel) value. Refer to [“SFN Reception Conditions and FFT Start Position” on page 99](#) for more information.

The green line with -35 dB above its right side is the peak limit line, which means only peaks above this line can be displayed in the peak table. To adjust the peak limit line, press **Peak Search, More 1 of 2, Peak Table**, and then enter your desired peak limit value.

Peak table window is very useful when there are more than one path in the channel. For more information, refer to [“Peak Table” on page 101](#).

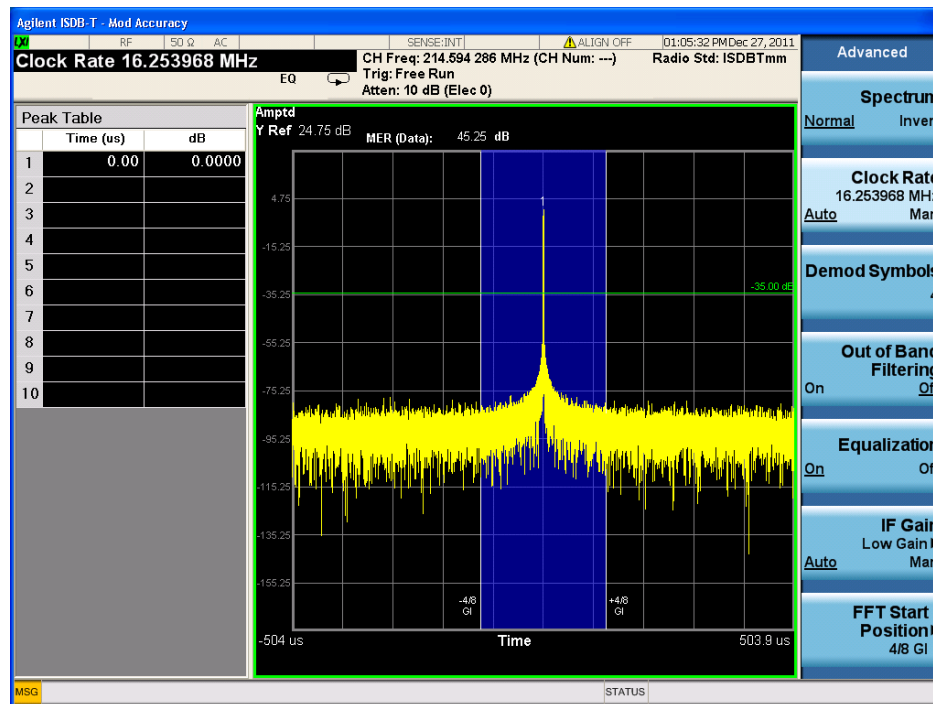

16 Press **View/Display, Spectral Flatness**.

This selects the spectral flatness view.

17 View the spectral flatness results.

The figure below displays the inband spectrum ripple.

Step

Notes

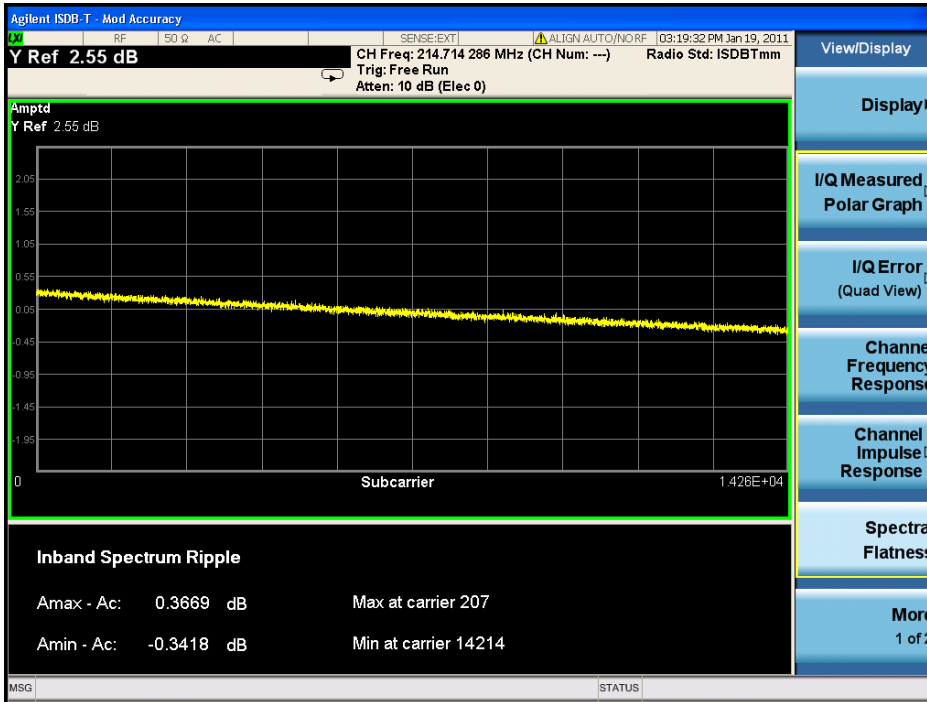

NOTE The **TMCC Decoding** and **AC Decoding** views are used to provide the TMCC decoding and AC decoding information for ISDB-T/Tsb signals. These two views do NOT support measuring ISDB-Tmm signals.

18 Press **View/Display, More 1 of 2, ISDB-Tmm Config**, and then press **ISDB-Tmm Config** again, **Super Segment Index, 0** (example).

This selects the ISDB-Tmm config view to see the configurations of each super segment of the ISDB-Tmm signal under test.

19 View the ISDB-Tmm Config results.

In the figure below, the top part shows the frame configuration, including the allocation of segments for each super segment. The bottom part shows the configuration parameters for the specified super segment.

Making ISDB-T/Tsb/Tmm Measurements
 ISDB-T/Tsb/Tmm Transmitter Measurements

Step Notes

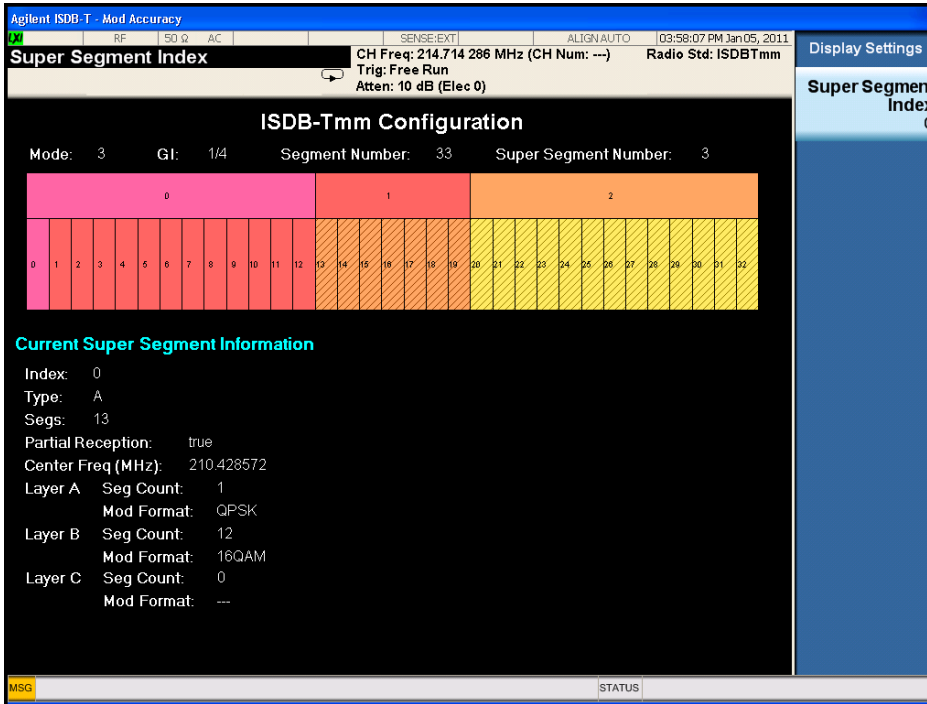

20 Press View/Display, More 1 of 2, MER vs. Segment.

This is to view the MER on each segment.

21 View the MER vs. Segment results.

The figure below lists the MER result of each segment and shows the super segment index and the layer (if the super segment is type A) the segment belongs to.

Step

Notes

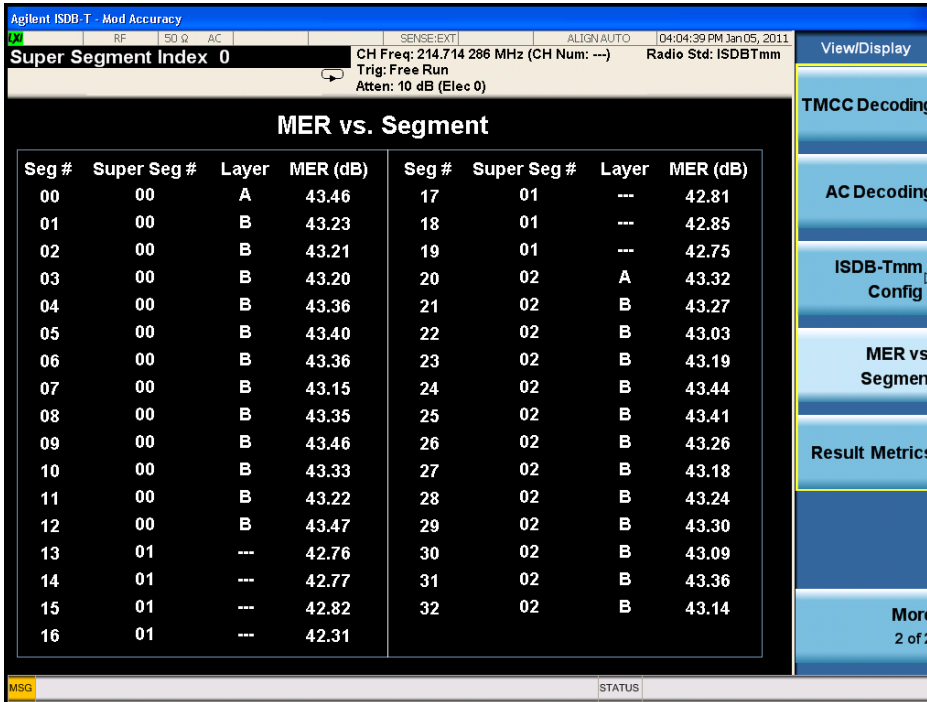

22 Press **View/Display, More 1 of 2, Result Metrics.**

This selects the result metrics view.

23 View the summary of the results.

This view is a summary of the modulation accuracy measurement results.

The region that begins with **For ISDB-T/Tsb** shows results only when the signal under test is ISDB-T or ISDB-Tsb.

Step

Notes

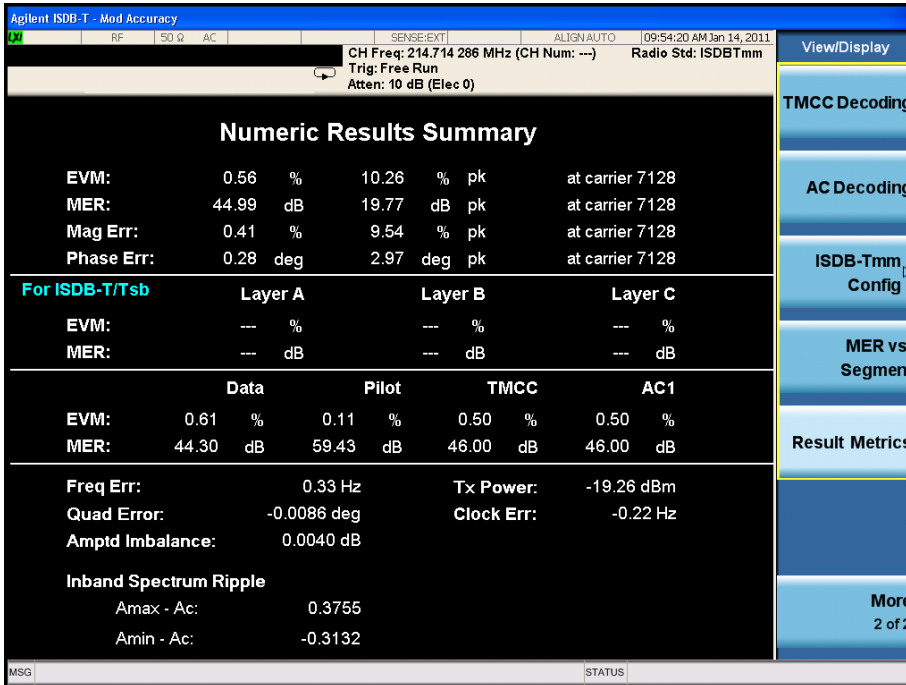

Creating ISDB-Tmm Configuration File

To demodulate the ISDB-Tmm signal that don't conform to the configuration A defined in ISDB-Tmm operational guidelines, a configuration file including the modulation parameters of the signal under test needs to be imported into the instrument.

The configuration file for the default settings, named as "ISDBTmmConfig_Demo.csv", can be found in the directory "D:\User_My_Documents\Instrument\My Documents\ISDBT\data\EVM", and it can be used as a template to create a new configuration file.

To create a new ISDB-Tmm configuration file,

1. Open the default setting file "ISDBTmmConfig_Demo.csv" with notepad or Microsoft excel (the signal analyzer doesn't provide this application).
2. Save it as another file and name it as you like.
3. Replace the default settings of the parameters with those of the signal under test, following the format and explanations below.

The Format of ISDB-Tmm Configuration File

Figure 2-6 on page 55 shows the format of the ISDB-Tmm configuration file. Each line is used to configure a parameter following the format "parameter name, parameter setting".

Figure 2-6 Template of ISDB-Tmm Configuration File

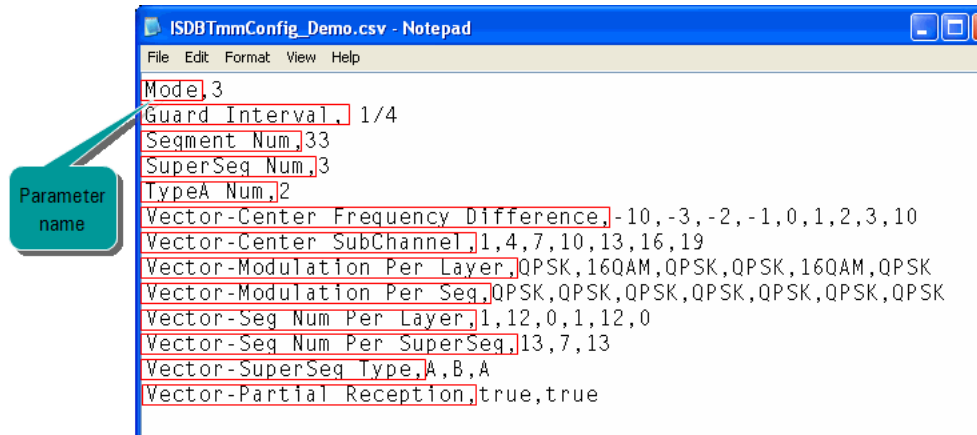

In the figure above, the words in the red boxes are the parameter names. Some parameter names begin with "Vector", which means the setting for this parameter contains an array of values separated by comma instead of a single value.

Parameter name	Range/Choices	Note
Mode	1, 2, 3	Set the mode of the ISDB-Tmm signal. The three modes represent three different spacings between OFDM carriers, which are approximately 4 kHz, 2 kHz, and 1 kHz for mode 1, mode 2, and mode 3.
Guard Interval	1/4, 1/8, 1/16, 1/32	Set the guard interval.
Segment Num	1~33	Set the segment count in the ISDB-Tmm signal under test.
SuperSeg Num	1~33	Set the super segment count in the ISDB-Tmm signal.
TypeA Num	0~2	Set the type A super segment count in the ISDB-Tmm signal. Type A super segment is the 13 segments OFDM frames compliant with ARIB STD B31. Then the type B super segment count is the value of SuperSeg Num minus Type A Num .

Parameter name	Range/Choices	Note
Vector-Center Frequency Difference	-16~16	<p>Set the position of the super segments in the 33-segment ISDB-Tmm OFDM frame in sequence, with the unit of segment. See Figure a) below for the definition of positions in a 33-segment frame when entering the Vector-Center Frequency Difference values.</p> <p>For type A super segments, only the position of the center segment in its 13-segment form needs to be entered.</p> <p>For type B super segments, the positions of every 1-segment need to be entered.</p> <p>See Figure b) below as an example.</p>

a) Definition of positions when setting Vector-Center Frequency Difference

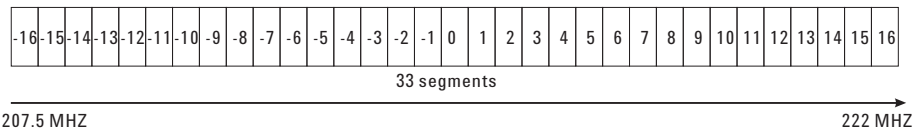

b) Example of setting the Vector-Center Frequency Difference

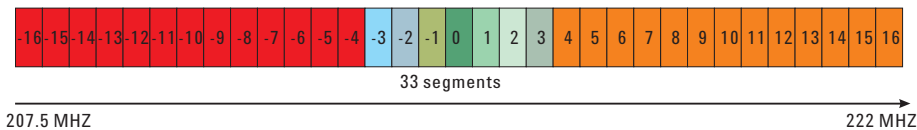

Vector-Center Frequency Difference, -10, -3, -2, -1, 0, 1, 2, 3, 10

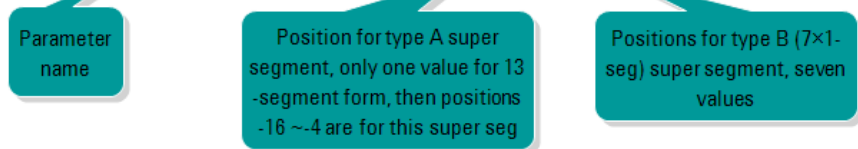

Vector-Center SubChannel	0~41	<p>This parameter is only for the type B super segment(s) in the ISDB-Tmm signal.</p> <p>Enter the center sub-channel number for each 1-segment in the type B super segment(s) in sequence.</p> <p>First, enter the center sub-channel number for each 1-seg in the 1st type B super segment, then the center sub-channel number for each 1-seg in the 2nd type B super segment, and go on if there are more type B super segments.</p> <p>Below is an example of setting vector center sub-channel number:</p>
--------------------------	------	---

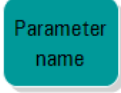
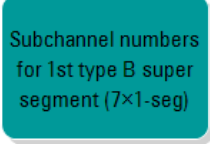
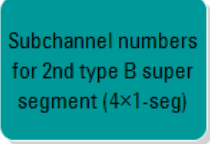
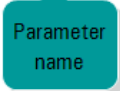
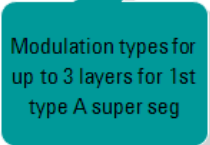
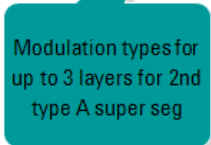
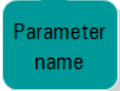
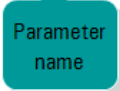
Parameter name	Range/Choices	Note
Vector-Center SubChannel 	1, 4, 7, 10, 13, 16, 19, 25, 28, 31, 34, ...  	
Vector-Modulation Per Layer 	QPSK, 16QAM, 64QAM QPSK, 16QAM, QPSK, QPSK, 16QAM, QPSK  	<p>This parameter is only for the type A super segment(s) in the ISDB-Tmm signal.</p> <p>Enter the modulation types for up to 3 layers of the type A super segment(s) in sequence. For each type A super segments, three values need to be entered. If the segment number of layer C is 0, the setting for layer C can be randomly selected.</p> <p>Below is an example of setting modulation types:</p>
Vector-Modulation Per Seg 	QPSK, 16QAM, 64QAM	<p>This parameter is only for the type B super segment(s) in the ISDB-Tmm signal.</p> <p>Enter the modulation type for each 1-segment in type B super segment(s) in sequence.</p> <p>It is similar to setting the Vector-Center SubChannel.</p>
Vector-Seg Num Per Layer 	0~13	<p>This parameter is only for the type A super segment(s) in the ISDB-Tmm signal.</p> <p>Enter the segment number included in each layers for the type A super segment(s) in sequence. For each type A super segment, three values need to be entered, even if the value is 0.</p> <p>It is similar to setting the Vector-Modulation Per Layer.</p>

Making ISDB-T/Tsb/Tmm Measurements
ISDB-T/Tsb/Tmm Transmitter Measurements

Parameter name	Range/Choices	Note
Vector-Seg Num Per SuperSeg	13 for type A super segments; 1~14 for type B super segments	Enter the segment number for each super segment in sequence. The number of the input values should be equal to the Superseg Num and the sum of the input values should be equal to the Segment Num.

Below is an example:

Vector-Seg Num Per SuperSeg, 13, 7, 13

Parameter name

Segment number in 1st super seg

Segment number in 2nd super seg

Vector-SuperSeg Type

A, B

Enter the super segment type for each super segment in sequence.

It is similar to setting the Vector-Seg Num Per SuperSeg.

Vector-Partial Reception

True, False

This parameter is only for the type A super segment(s) in the ISDB-Tmm signal.

Set whether partial reception is on (True) or off (False) for each type A super segment in sequence.

Below is an example:

Vector-Partial Reception, true, true

Parameter name

Partial reception status in 1st type A super seg

Occupied Bandwidth Measurements

This section explains how to make the Occupied Bandwidth measurement on an ISDB-T/Tsb/Tmm transmitter. The instrument measures power across the band, and then calculates its 99.0% power bandwidth.

Step	Notes
1 Press Mode, ISDB-T .	
2 Press Mode Preset .	
3 Press Mode Setup, Radio Std, ISDB-T .	<p>This selects the radio standard for the signal under test. The standards available for selection under Radio Std menu depend on the licenses installed in your instrument:</p> <ul style="list-style-type: none"> • If only N6155A-2FP (W6155A-2FP for CXA) is installed, two standards are available: ISDB-T and ISDB-Tsb. • If both N6155A-2FP (W6155A-2FP for CXA) and N6155A-3FP (W6155A-3FP for CXA) are installed, three standards are available: ISDB-T, ISDB-Tsb, and ISDB-Tmm. <p>Note that if the Radio Std is set to ISDB-Tmm, the center frequency is changed to 214.714286 MHz automatically as specified in the ISDB-Tmm standard.</p>
<p>4 Do one of the following to set center frequency:</p> <ul style="list-style-type: none"> • Press FREQ Channel, Center Freq, 713.142857, MHz. • Press FREQ Channel, Chan Table, NTSC-J, NTSC-J AIR, and then press FREQ Channel, Channel, 53. 	<p>The first method is to enter the frequency directly.</p> <p>The second method is to set the frequency through channel table. Multiple channel tables are predefined in the instrument, including NTSC-M, NTSC-J, NTSC-Brazil, PAL-M, PAL-I, PAL-B/G, and PAL-D/K.</p> <p>You can change the definition of the channel table following the steps in “Customizing the Channel Table Definition” on page 19.</p>
5 Press Meas, Occupied BW .	This selects the occupied BW measurement.
6 View the occupied BW measurement results.	<p>In the figure below, the graphic window shows the spectrum for the current signal, and the text window shows the occupied bandwidth of the specified percentage and the x dB bandwidth of the specified x dB.</p> <p>The predefined settings are compliant with the specs. You can customize the occupied BW measurement by setting the parameters, such as OBW power, x dB, and limit under Meas Setup menu.</p>

Step

Notes

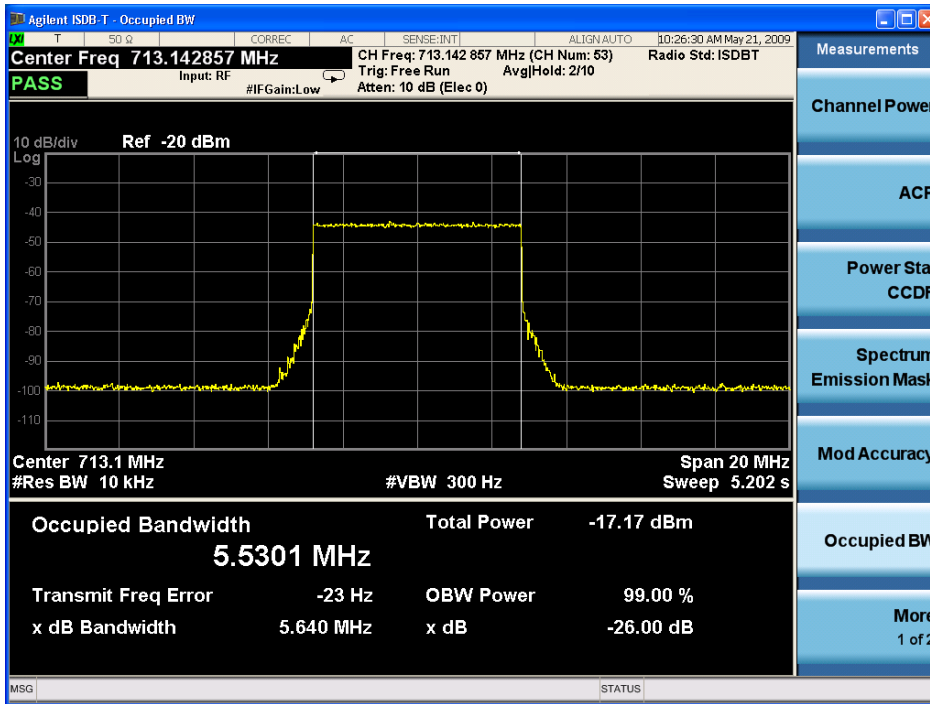

Troubleshooting Hints

Any distortion such as harmonics or intermodulation, for example, produces undesirable power outside the specified bandwidth.

Shoulders on either side of the spectrum shape indicate spectral regrowth and intermodulation. Rounding or sloping of the top shape can indicate filter shape problems.

Monitor Spectrum Measurements

This section describes how to make a Monitor Spectrum measurement on an ISDB-T/Tsb/Tmm transmitter. Monitor Spectrum measurements show a spectrum domain display of the ISDB-T/Tsb/Tmm signal.

Step	Notes
1 Press Mode, ISDB-T .	
2 Press Mode Preset .	
3 Press Mode Setup, Radio Std, ISDB-T .	<p>This selects the radio standard for the signal under test. The standards available for selection under Radio Std menu depend on the licenses installed in your instrument:</p> <ul style="list-style-type: none"> • If only N6155A-2FP (W6155A-2FP for CXA) is installed, two standards are available: ISDB-T and ISDB-Tsb. • If both N6155A-2FP (W6155A-2FP for CXA) and N6155A-3FP (W6155A-3FP for CXA) are installed, three standards are available: ISDB-T, ISDB-Tsb, and ISDB-Tmm. <p>Note that if the Radio Std is set to ISDB-Tmm, the center frequency is changed to 214.714286 MHz automatically as specified in the ISDB-Tmm standard.</p>
<p>4 Do one of the following to set center frequency:</p> <ul style="list-style-type: none"> • Press FREQ Channel, Center Freq, 713.142857, MHz. • Press FREQ Channel, Chan Table, NTSC-J, NTSC-J AIR, and then press FREQ Channel, Channel, 53. 	<p>The first method is to enter the frequency directly.</p> <p>The second method is to set the frequency through channel table. Multiple channel tables are predefined in the instrument, including NTSC-M, NTSC-J, NTSC-Brazil, PAL-M, PAL-I, PAL-B/G, and PAL-D/K.</p> <p>You can change the definition of the channel table following the steps in “Customizing the Channel Table Definition” on page 19.</p>
5 Press Meas, Monitor Spectrum .	This selects monitor spectrum view.
6 View the monitor spectrum results.	The default display shows the Current (yellow trace) data.

Making ISDB-T/Tsb/Tmm Measurements

ISDB-T/Tsb/Tmm Transmitter Measurements

Step

Notes

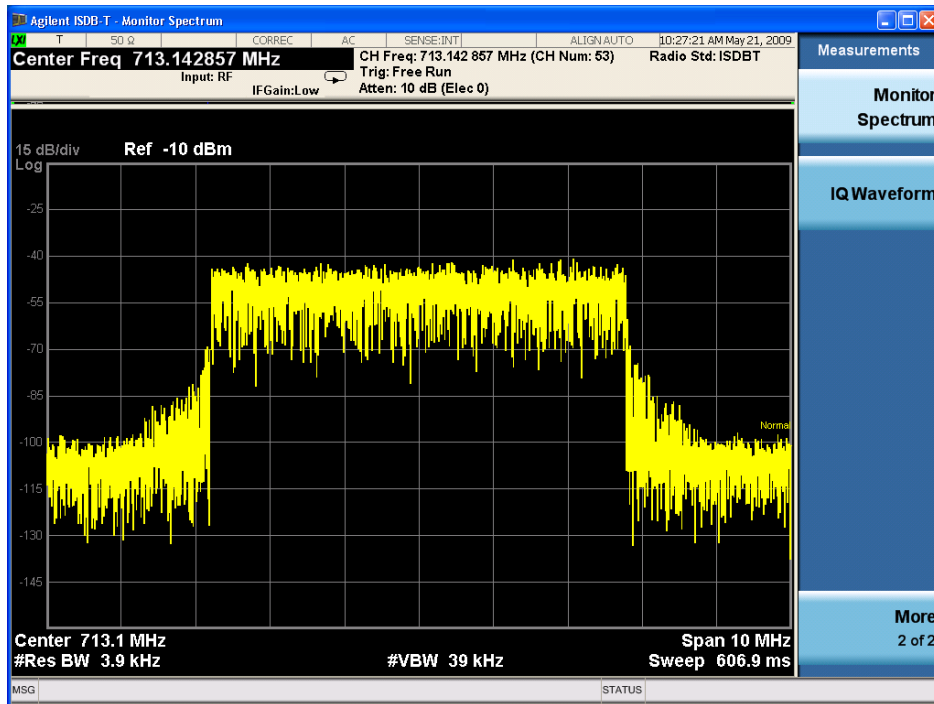

7 (Optional) Press **Marker Function, Marker Noise.**

This turns on the Marker Function. The figure below is an example for marker noise. You can also select Band/Interval Power and Band/Interval Density to see the power or power density in a specified band, which is set using the keys under the Band Adjust menu.

Step

Notes

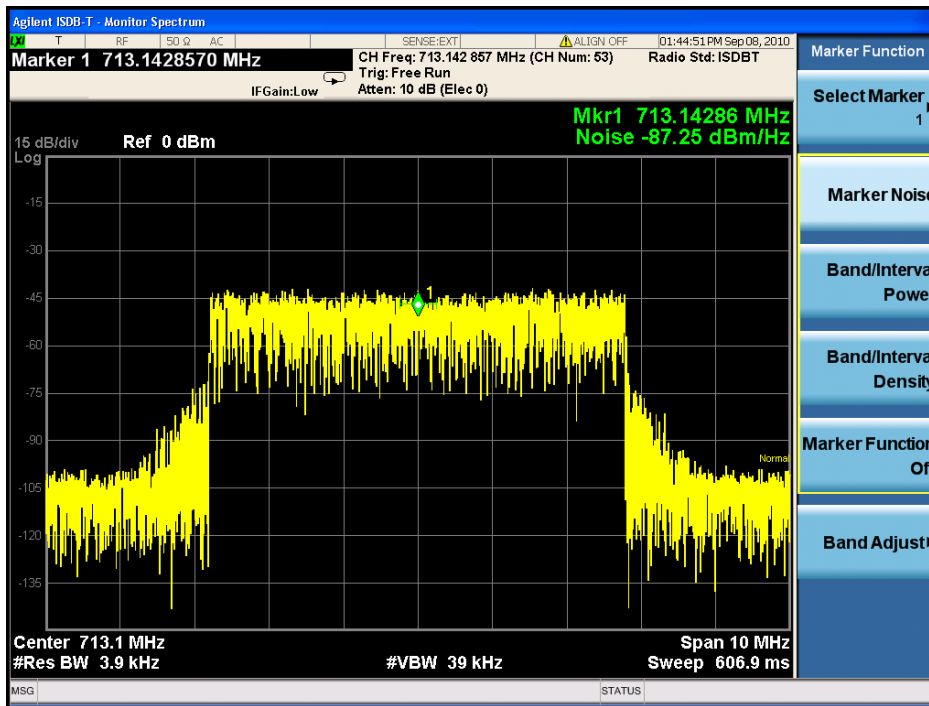

8 (Optional) To compare the current trace with the average/max hold/min hold trace, perform the following steps:

- Press **Trace/Detector, Select Trace, Trace 1**, and then toggle **Update to Off**.
- Press **Select Trace, Trace 2**, press **Max Hold**, and then toggle **Update to On, Display to Show**.

The dark yellow trace is the clear write trace, and the blue trace is the max hold trace. You can also add other traces using the same procedure.

Making ISDB-T/Tsb/Tmm Measurements

ISDB-T/Tsb/Tmm Transmitter Measurements

Step

Notes

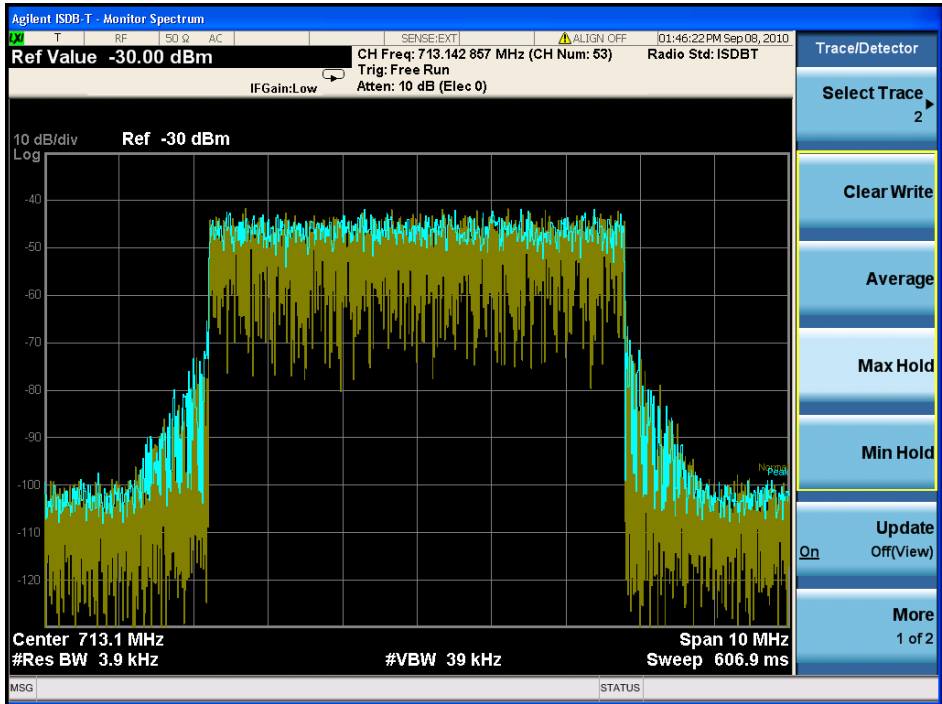

IQ Waveform (Time Domain) Measurements

This section explains how to make a Waveform (time domain) measurement on an ISDB-T/Tsb/Tmm transmitter. The measurement of I and Q modulated waveforms in the time domain discloses the voltages which comprise the complex modulated waveform of a digital signal.

IQ Waveform measurements can be used to measure the BBIQ (Baseband I/Q) signals. For the detailed measurement procedure, refer to [“Using Option BBA Baseband I/Q Inputs” on page 73](#).

Step	Notes
1 Press Mode, ISDB-T .	
2 Press Mode Preset .	
3 Press Mode Setup, Radio Std, ISDB-T .	<p>This selects the radio standard for the signal under test. The standards available for selection under Radio Std menu depend on the licenses installed in your instrument:</p> <ul style="list-style-type: none"> ▪ If only N6155A-2FP (W6155A-2FP for CXA) is installed, two standards are available: ISDB-T and ISDB-Tsb. ▪ If both N6155A-2FP (W6155A-2FP for CXA) and N6155A-3FP (W6155A-3FP for CXA) are installed, three standards are available: ISDB-T, ISDB-Tsb, and ISDB-Tmm. <p>Note that if the Radio Std is set to ISDB-Tmm, the center frequency is changed to 214.714286 MHz automatically as specified in the ISDB-Tmm standard.</p>
<p>4 Do one of the following to set center frequency:</p> <ul style="list-style-type: none"> ▪ Press FREQ Channel, Center Freq, 713.142857, MHz. ▪ Press FREQ Channel, Chan Table, NTSC-J, NTSC-J AIR, and then press FREQ Channel, Channel, 53. 	<p>The first method is to enter the frequency directly.</p> <p>The second method is to set the frequency through channel table. Multiple channel tables are predefined in the instrument, including NTSC-M, NTSC-J, NTSC-Brazil, PAL-M, PAL-I, PAL-B/G, and PAL-D/K.</p> <p>You can change the definition of the channel table following the steps in “Customizing the Channel Table Definition” on page 19.</p>
5 Press Meas, IQ Waveform .	This selects the IQ waveform measurements.
6 Press View/Display ,	
7 View the RF envelope (default view) results.	The following picture shows the RF envelope results in the graphic windows, and shows the mean power and peak-to-mean power results in the text window.

Making ISDB-T/Tsb/Tmm Measurements

ISDB-T/Tsb/Tmm Transmitter Measurements

Step

Notes

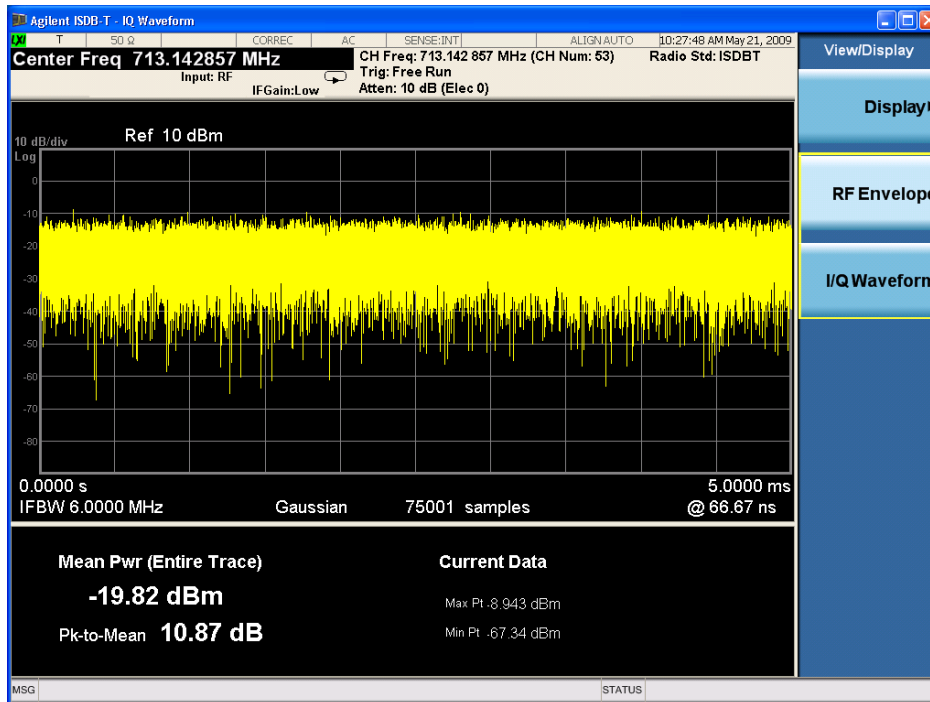

8 Press View/Display, I/Q Waveform. This selects the I/Q waveform view.

9 View the I/Q waveform results. The I/Q waveform view displays the I (yellow trace) and Q (blue trace) waveforms on the same graph in terms of voltage versus time in linear scale.

Step

Notes

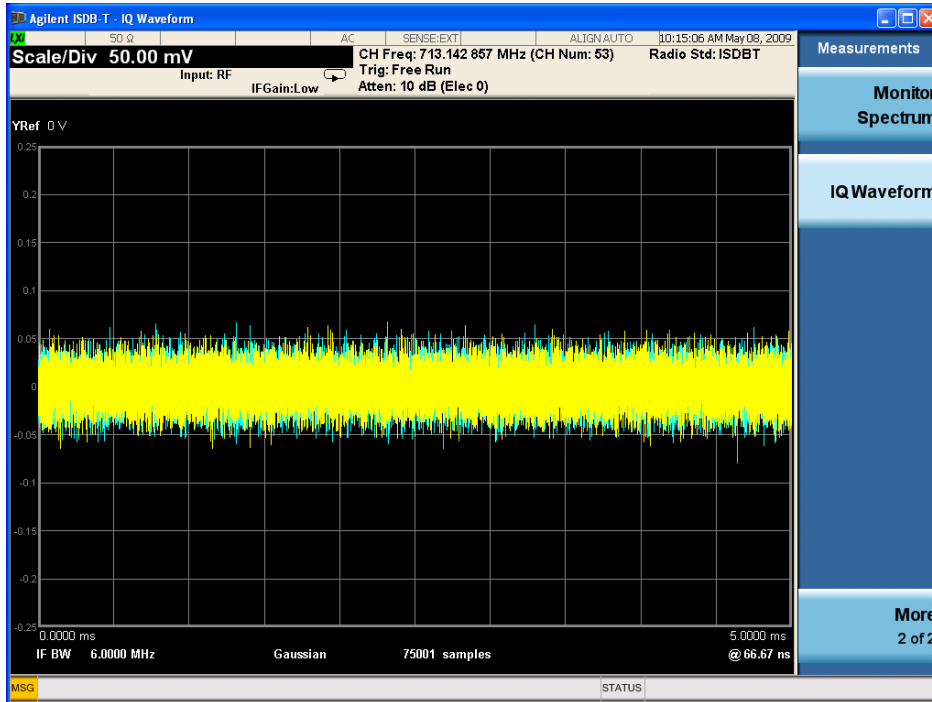

10 (Optional) Press **AMPTD Y Scale**, and configure the settings for the Y axis to a convenient scale for viewing.

11 (Optional) Press **Span X Scale**, and configure the settings for the X axis to a convenient time scale for viewing.

12 (Optional) Press **Marker Function** and select **Marker Noise**, **Band/Interval Power**, or **Band/Interval Density**. You can use band adjust to set frequency span for those marker functions.

ISDB-T/Tsb/Tmm SFN Field Measurements

This section describes how to make ISDB-T/Tsb/Tmm tests in SFN field scenarios. SFN field test generally requires measurement results like power level, MER, channel impulse response, and so on. It is aimed to investigate and verify the SFN network at a certain location. As the test system and procedure for ISDB-T/Tsb/Tmm signals are similar, ISDB-T signal is taken as an example in this section.

The test system below enables you to test the SFN network in adverse reception conditions. It is robust enough for pre-echoes, post-echoes, and even for the worst case 0 dB echo in the propagation environment, providing stable MER and channel impulse response results. Refer to [“SFN Reception Conditions and FFT Start Position” on page 99](#) for more information.

Setting Up the Test System

The SFN field measurement is to test the ISDB-T/Tsb/Tmm over-the-air signals in the SFN network. The measurement system is shown in [Figure 2-7](#).

To perform the measurement, connect an appropriate antenna to the X-Series signal analyzer. As the power level of the over-the-air signal may be very low, it is recommended to use an antenna with some gain and make sure the impedances of the antenna and the RF input port of the signal analyzer match with each other.

Figure 2-7

ISDB-T/Tsb/Tmm SFN Field Measurement System

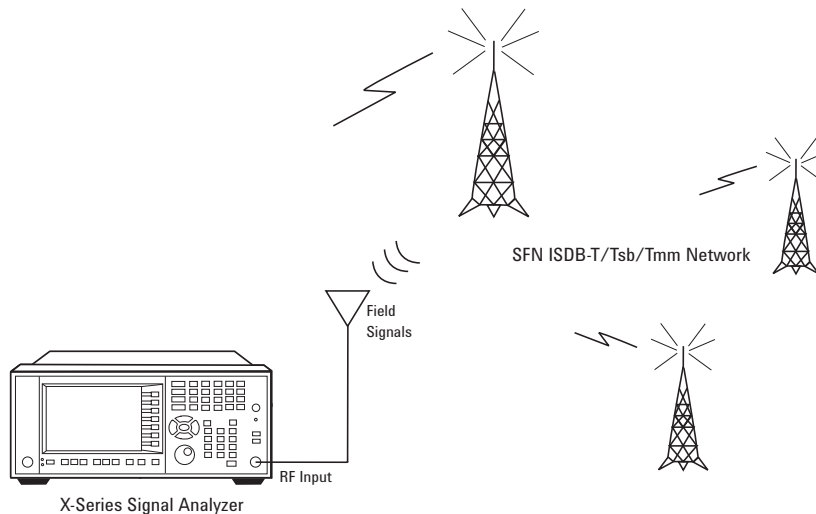

ISDB-T Signal Under Test

In this example, Keysight N5182A MXG vector signal generator and N7623B signal studio for digital video are used to simulate ISDB-T signals in the SFN network. The detailed parameters are as below.

Power level: -60 dBm

Frequency: 713.142857 MHz

Channel bandwidth: 6 MHz
 Mode: Mode 3
 Layer A: 1 Segment; Code rate = 2/3; QPSK
 Layer B: 12 Segment; Code rate = 3/4; 64 QAM
 Partial Reception: On
 Guard interval: 1/8
 S/N: 30 dB

The fading channel used to simulate the SFN propagation environment is shown as below. In the static delay profile, three paths are used, including the main channel, a pre-echo, and a post-echo.

Tap number	Delay (μ s)	Level (dB)
1	0	-10
2	40	0
3	80	-10

Measurement Procedure

Step	Notes
1 Press Mode, ISDB-T .	
2 Press Mode Preset .	
3 Press FREQ Channel, Center Freq, 713.142857, MHz .	This sets the center frequency.
4 Press Mode Setup, Radio Std, ISDB-T .	
5 Press Mode Setup, Channel BW, 6 MHz .	This sets the channel bandwidth according to the signal under test.
6 Press Meas, Channel Power and then <ul style="list-style-type: none"> • Press AMPTD Y Scale, Attenuation, set the Mech Atten to 0 dB and toggle Enable Elec Atten to Off. • Press AMPTD Y Scale, More 1 of 2, Internal Preamp, Low Band [3.60 GHz]. 	<p>This is to select the channel power measurement and turn off the attenuator and turn on the preamplifier inside the signal analyzer to make it suitable to measure low power level signals.</p> <p>Note that the preamplifier requires option P03 installed in the X-Series signal analyzer.</p>

Step	Notes
7	View the spectrum and the channel power of the signal. Typically, the signal analyzer can measure signals as low as -80 dBm. If the signal level is about -60 dBm as in the graphic below, the results can be pretty stable.

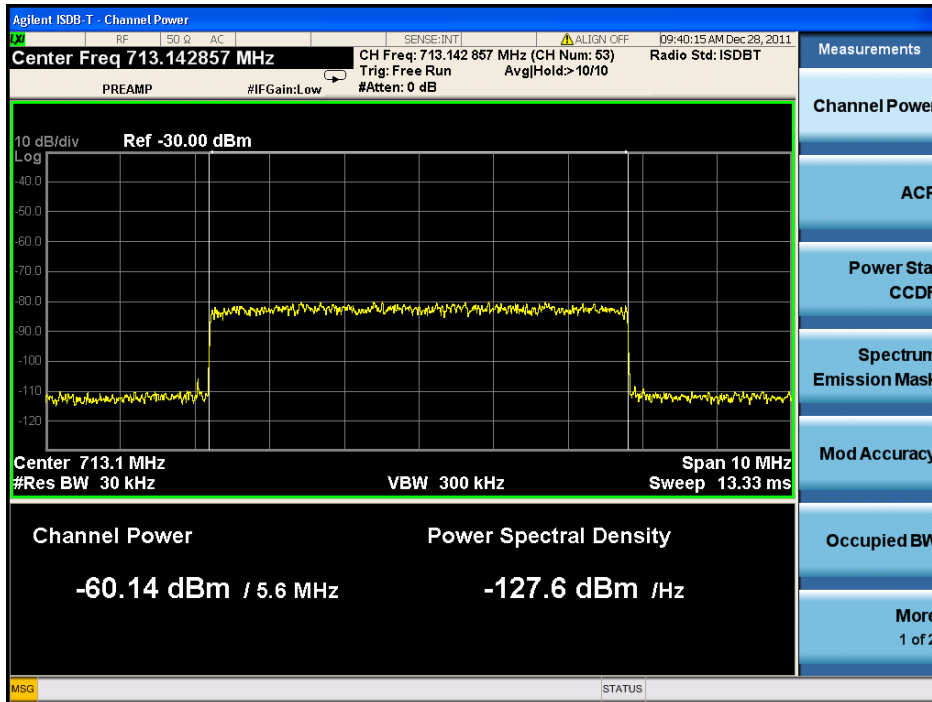

8	Press Meas, Mod Accuracy .	This selects the modulation accuracy measurement.
9	Press View/Display, I/Q Measured Polar Graph (default view).	This selects the I/Q measured polar graph view.
10	Press Meas Setup, Advanced , and toggle Equalization to On.	The recovered I/Q points and MER/BER results can be improved through turning on the equalizer.
11	Press Meas Setup, Auto Detect .	This is to auto-detect OFDM parameters. Note that you need to perform auto-detect every time you change the RF channel.
12	Press Meas Setup, Advanced, More 1 of 2, FFT Start Position and try different options to find the optimal choice with which you can get the largest and the most stable MER result.	This sets the FFT Start Position which will determines the place of the FFT window. For more information, refer to “SFN Reception Conditions and FFT Start Position” on page 99.
13	View the constellation graphic and the MER results.	

Step

Notes

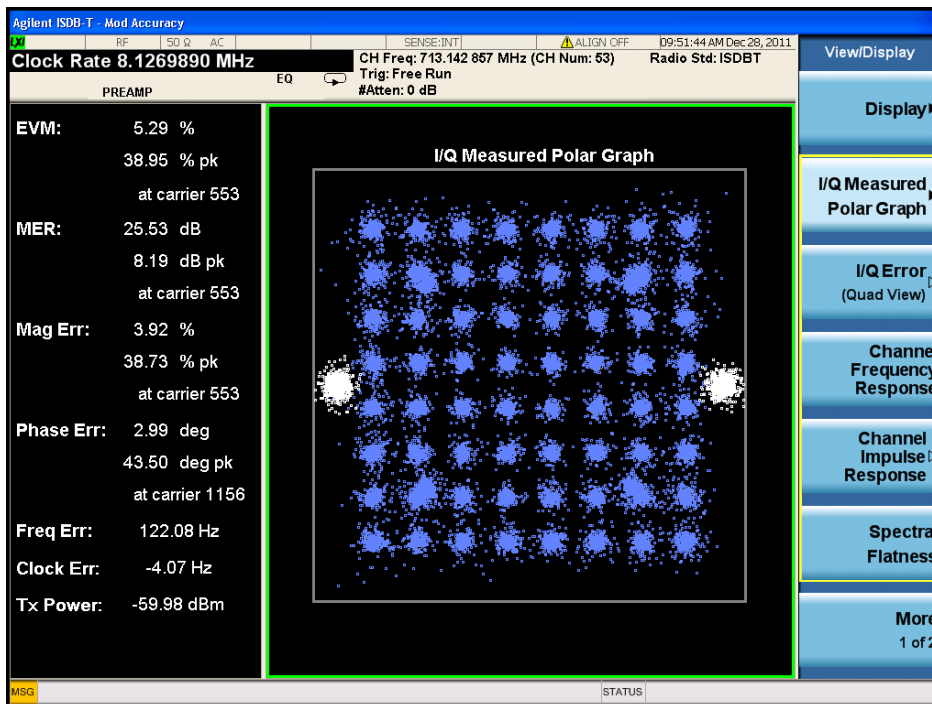

14 Press **View/Display, Channel Impulse Response**.

This is to view the channel impulse response.

15 In this view, you can further adjust the FFT start position by pressing **Meas Setup, Advanced, More 1 of 2, FFT Start Position** and make sure the main paths are included in the blue bar displayed on the screen.

While adjusting the FFT Start Position, you can refer to the MER result displayed on the top of the channel impulse response view.

For more information, refer to [“SFN Reception Conditions and FFT Start Position”](#) on page 99.

Step

Notes

16 View the channel impulse response results.

In the figure below, the graphic window shows the channel impulse response trace and the table window lists the delay and power level of three paths in the fading channel under test.

The blue bar with the range of GI indicates that all the paths included are used to reconstruct the signal for measurement. The position of the blue bar will be changed with FFT Start Position (under **Meas Setup, Advanced, More 1 of 2** menu) value.

The green line with -35 dB above its right side is the peak limit line, which means only peaks above this line can be displayed in the peak table. To adjust the peak limit line, press **Peak Search, More 1 of 2, Peak Table** and enter your desired peak limit value.

For more information, refer to [“Peak Table” on page 101](#).

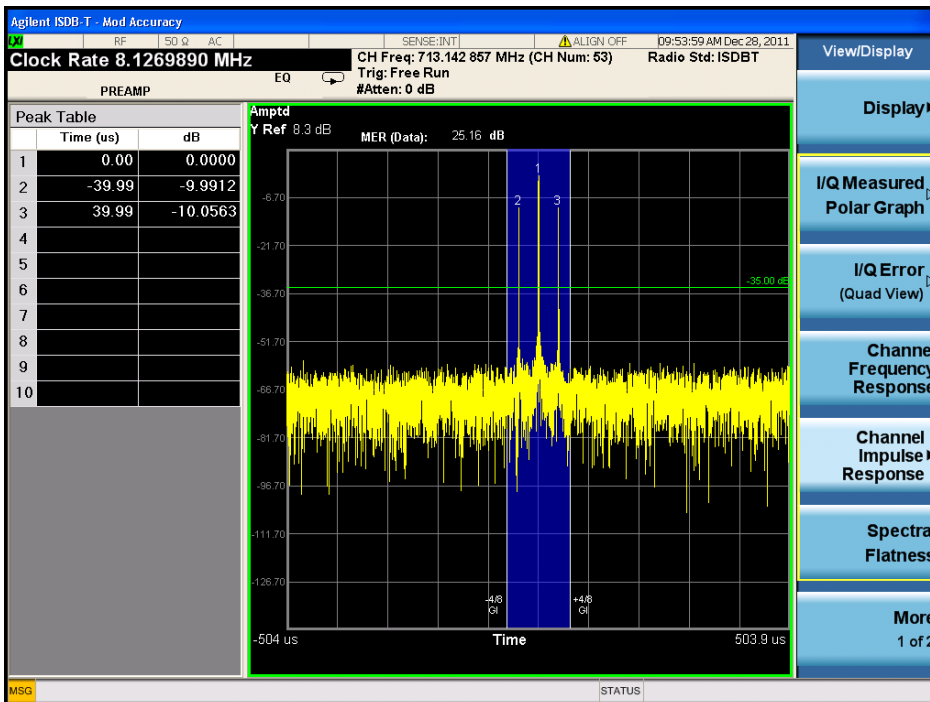

Using Option BBA Baseband I/Q Inputs

Baseband I/Q Measurements Available for X-Series Signal Analyzers

The following table shows the measurements that can be made using Baseband I/Q inputs:

Table 2-4

BBIQ Supported Measurements vs. Mode

Mode	Measurements
GSM	IQ Waveform GMSK Phase & Freq EDGE EVM
TD-SCDMA	IQ Waveform Power Stat CCDF Code Domain Mod Accuracy
cdma2000	IQ Waveform Power Stat CCDF Code Domain Mod Accuracy QPSK EVM
DTMB (CTTB)	IQ Waveform Power Stat CCDF Mod Accuracy
DVB-T/H with T2	IQ Waveform Power Stat CCDF DVB-T/H Mod Accuracy DVB-T2 Mod Accuracy
ISDB-T	IQ Waveform Power Stat CCDF Mod Accuracy
CMMB	IQ Waveform Power Stat CCDF Mod Accuracy
Digital Cable TV	IQ Waveform Power Stat CCDF Mod Accuracy
IQ Analyzer (Basic)	IQ Waveform Complex Spectrum

Baseband I/Q Measurement Overview

The Baseband I/Q functionality is a hardware option, Option BBA. If the option is not installed in the instrument, the I/Q functionality cannot be enabled.

The Baseband I/Q option provides four input ports and one Calibration Output port. The input ports are I, I-bar, Q, and Q-bar. The I and I-bar together compose the I channel and the Q and Q-bar together compose the Q channel. Each channel has two modes of operation:

Single Ended
(unbalanced)

In this mode, only the main port (I or Q) is used and the complementary ports (I-bar or Q-bar) are ignored. The I and Q ports are in single-ended mode when Differential “Off” is selected.

Differential
(balanced)

In this mode, both main and complementary ports are used. To activate this mode, select Differential “On” from the I and Q Setup softkey menus.

The system supports a variety of input passive probes as well as the Keysight 1153A active differential probe using the Infinimax probe interface.

NOTE

To avoid duplication, this section describes only the details unique to using the baseband I/Q inputs. For generic measurement details, refer to the previous [“Making ISDB-T/Tsb/Tmm Measurements” on page 11](#) sections.

To make measurements using baseband I/Q Inputs, make the following selections:

Step	Notes
1 Select a measurement that supports baseband I/Q inputs by pressing Meas .	Table 2-4 on page 73 lists the measurements that support baseband I/Q inputs in each mode.
2 Select the I/Q Path. Press Input/Output, I/Q, I/Q Path , and then select from the choices present on the screen.	The path selected in this step is shown at the top of the measurement screen.
3 Select the appropriate circuit location and probe(s) for measurements.	For details see “Selecting Input Probes for Baseband Measurements” on page 108 in the Concepts chapter.
4 Select baseband I/Q input connectors and connect the I/Q signals to the corresponding I/Q ports on the instrument.	

Step	Notes
<p>5 If you have set the I/Q Path to I+jQ or to I Only, press I Setup.</p> <p>A. Select whether Differential (Balanced) input is On or Off.</p> <p>B. Select the input impedance, Input Z.</p> <p>C. Input a Skew value in seconds.</p> <p>D. Set up the I Probe by pressing I Probe.</p> <p>a. Select probe Attenuation.</p> <p>b. Calibrate the probe. Press Calibrate... to start the calibration procedure. Follow the calibration procedure, clicking Next at the end of each step.</p>	
<p>6 If you have set the I/Q Path to I+jQ or to Q Only, press Q Setup.</p> <p>A. Select whether Differential (Balanced) input is On or Off.</p> <p>B. Select the input impedance, Input Z.</p> <p>C. Input a Skew value in seconds.</p> <p>D. Set up the I Probe by pressing I Probe.</p> <p>a. Select probe Attenuation.</p> <p>b. Calibrate the probe. Press Calibrate... to start the calibration procedure. Follow the calibration procedure, clicking Next at the end of each step.</p>	
<p>7 Select the reference impedance by pressing Reference Z and inputting a value from one ohm to one megohm.</p>	The impedance selected is shown at the top of the measurement screen.
<p>8 If you are using cables that were not calibrated in the probe calibration step, press I/Q Cable Calibrate..., follow the calibration procedure, and click Next at the end of each step.</p>	
<p>9 After completing the baseband IQ setup procedures, make your desired measurement.</p>	

Measuring Low IF Signals with BBIQ Input

Baseband IQ input can also be used to measure the low IF (intermediate frequency) ISDB-T/Tsb/Tmm signals. It provides better and clearer measurement results than measuring them from RF input directly. The center frequency of the input signal can be very low, for example, 3 MHz for the 6 MHz signals.

This is helpful when making tests on some low-IF tuners, which down-converts the input TV signal to extremely low IF directly, such as 3 MHz.

Signal under test (example):

Radio Standard: ISDB-T

Center Frequency: 3 MHz

Channel Bandwidth: 6 MHz

Mode: Mode 3 (5617 carriers)

Guard Interval: 1/8

Layer A: 1 Segment; Code Rate = 2/3; QPSK; I (Time Interleaving length) = 4

Layer B: 4 Segment; Code Rate = 3/4; 64 QAM; I = 2

Layer C: 8 Segment; Code Rate = 5/6; 16 QAM; I = 4

Measurement Procedure

Step	Notes
1 Connect the low IF signal under test to the I Input port on the front panel of signal analyzer with appropriate cables and connectors.	
2 On the signal analyzer, press Meas, Mod Accuracy .	This selects a measurement that supports BBIQ measurements. You can choose Power Stat CCDF or IQ Waveform as well.
3 Press Input/Output, I/Q, I/Q Path, I Only , and then set the parameters under I Setup .	This selects the BBIQ input path as I only and sets up the I path.
4 Press FREQ Channel, Center Freq, 3, MHz .	This sets the center frequency to 3 MHz, and sets up the mode and measurement parameters.
5 Press Mode Setup, Radio Std, ISDB-T, Channel BW, 6 MHz , and then press Meas Setup, Auto Detect .	This sets up the parameters for the ISDB-T mode and modulation accuracy measurement. Refer to “Modulation Accuracy Measurements” on page 31 for more details.
6 View the measurement results.	Here is an example of the I/Q measured polar graph view.

Step

Notes

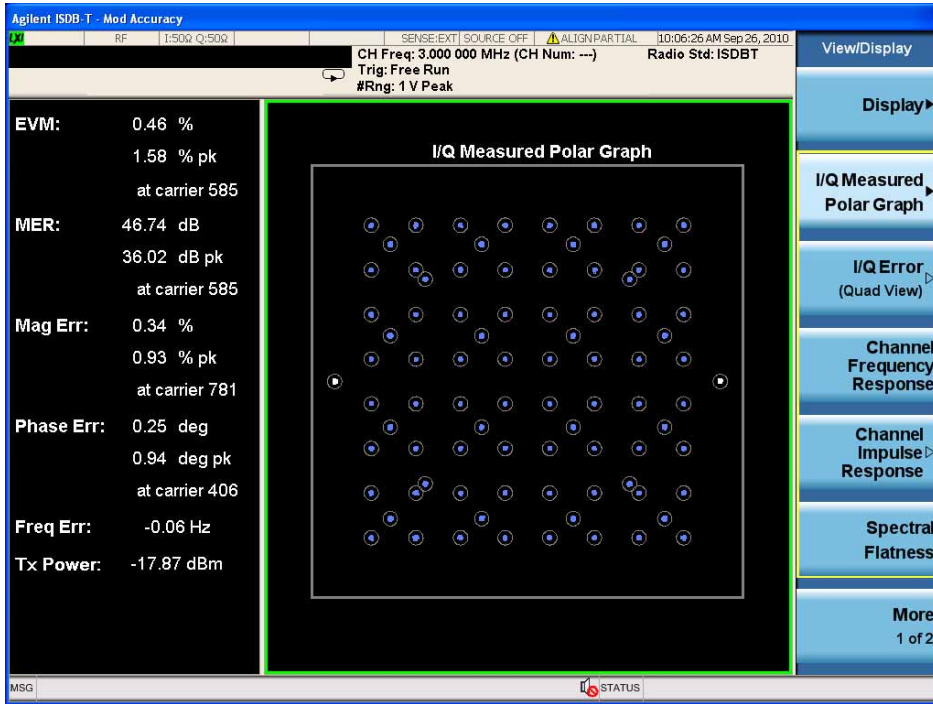

Making ISDB-T/Tsb/Tmm Measurements
Using Option BBA Baseband I/Q Inputs

3 Concepts

This chapter provides details about ISDB-T/Tsb/Tmm broadcast systems, and explains how the various measurements are performed by the instrument. Suggestions for optimizing and troubleshooting your setup are provided, along with a list of related documents that are referenced for further information.

ISDB-T/Tsb Technical Overview

ISDB-T/Tsb standards are the digital terrestrial broadcasting systems developed by the Association of Radio Industries and Business (ARIB) in Japan. ISDB-T, as a terrestrial broadcasting system, is adopted by Japan and Brazil currently. ISDB-Tsb, the narrow-band ISDB-T, is used for audio and data program transmissions. The system and specifications of ISDB-Tsb are almost the same as ISDB-T, except that the bandwidth is narrower and there are only one or three segments in the channel.

The block diagram of ISDB-T system is shown in [Figure 3-1](#).

The multiple TSs (transport stream) from the MPEG-2 output are re-multiplexed to one data stream first. After going through an outer coding (a shortened RS code), the data stream is divided into a maximum of three layers based on the organization information.

Next, the layers are then processed by the parallel processors. The parallel processors mainly include energy dispersal, delay adjustment, byte interleaving, convolutional coding, bit interleaving, and mapping. Note that each layer can have its own error correction, time interleaving length and modulation scheme.

Figure 3-1 *Block Diagram of ISDB-T*

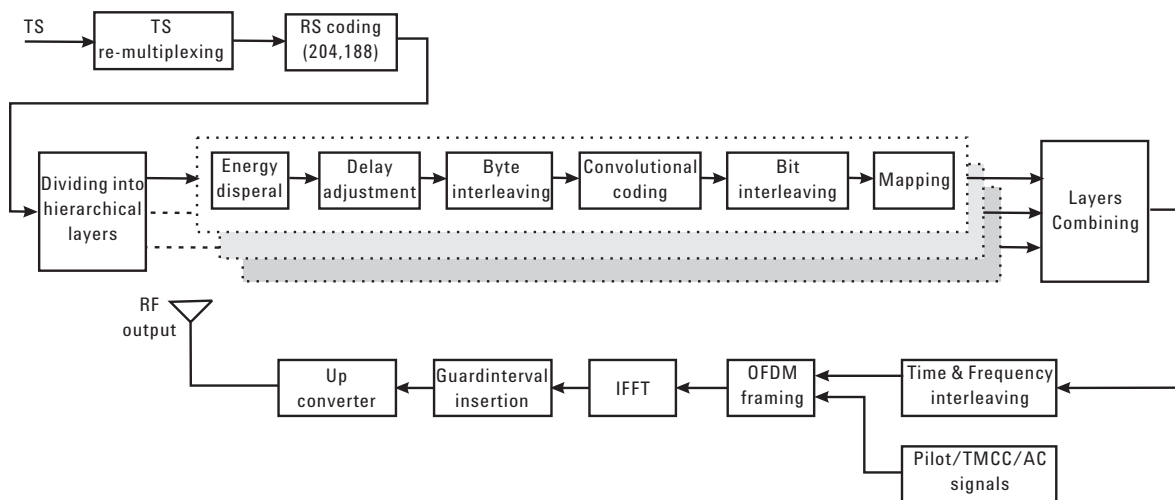

After that, the data from different layers are combined to one data stream again. The time and frequency interleaving is applied to decrease the transmission errors caused by burst noise and multi-path interference in mobile reception. Then, pilot, TMCC, and AC are inserted to form the OFDM frame. The pilot, TMCC and AC are used to make sure that the receiver can correctly demodulate and decode the data with different transmission configurations in each layer.

After going through the IFFT process and guard interval insertion, the data is upconverted to the RF frequency. The key parameters of ISDB-T are shown in [Table 3-1](#). For more details, refer to [\[2\]](#).

Table 3-1 *Key Parameters of ISDB-T*

Mode	Mode 1 (2k)	Mode 2 (4k)	Mode 3 (8k)
Segment Num.	13		
Carrier Spacing	3.968 kHz	1.984 KHz	0.992 kHz
Band width	5.575 MHz	5.573 MHz	5.572 MHz
Total Carriers	1405	2809	5617
Modulation Scheme	QPSK, 16QAM, 64QAM, DQPSK		
Symbol Num Per Frame	204		
Guard Interval	1/4, 1/8, 1/16, and 1/32		
Outer Code	RS(204,188)		
Inner Code	Convolutional Code (1/2, 2/3, 3/4, 5/6, 7/8)		
Data Rate (Mbps)	3.65 ~ 23.2		

Hierarchical Transmission and Partial Reception

ISDB-T supports hierarchical transmission by introducing hierarchical layers, which means different services, such as HDTV, multi-channel SDTV, and data, can be transmitted in one frequency channel. There are 13 OFDM segments in the ISDB-T transmission channel. Each layer consists one or more segments and has its own transmission parameters (e.g., the inner coding rate, modulation scheme and time interleaving length). A maximum of 3 layers can be provided.

Figure 3-2 presents the general conception of hierarchical transmission and partial reception.

Partial reception relates to the segment at the center of the transmission spectrum. The range of frequency interleaving can be limited within the segment, so that a narrow band (1-seg) receiver can receive the services contained in the segment. Note that the segment used for partial reception is also considered as a hierarchal layer.

Figure 3-2 Hierarchical Transmission and Partial Reception in ISDB-T

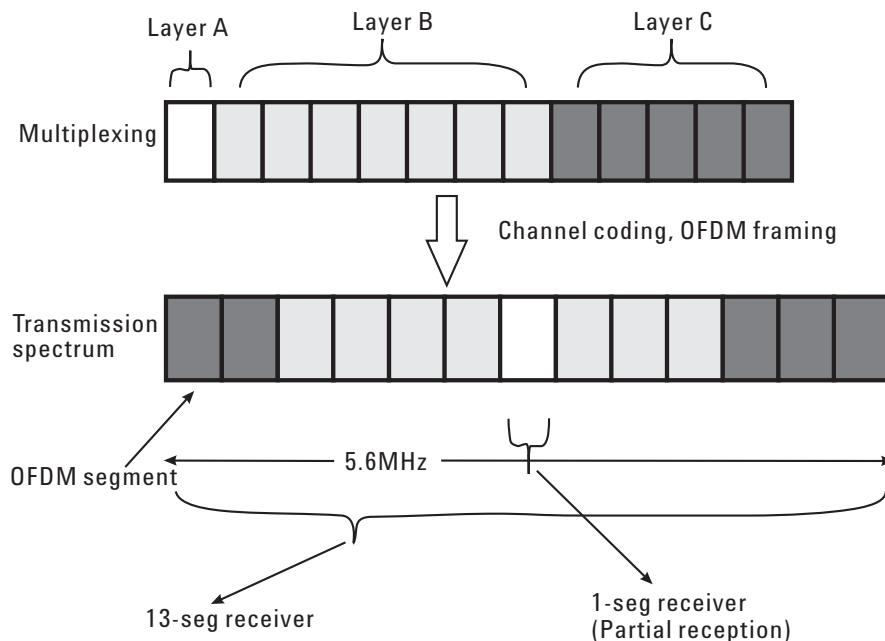

Interleaving

As shown in [Figure 3-1](#), four kinds of interleaving are used in ISDB-T system. The effect of each interleaving is discussed below.

- Byte interleaving is used between the RS coding and convolutional coding to randomize the burst errors of the Viterbi decoding output.
- Bit interleaving is used after the convolutional coding to randomize the burst errors before Viterbi decoding.
- Time interleaving is used after mapping and layer combining to randomize the burst errors in time domain caused by the impulse interferences and fadings in mobile reception.
- Frequency interleaving is used after time interleaving to randomize the burst errors of frequency domain caused by multi-path and carrier interferences in mobile reception.

OFDM

ISDB-T uses Orthogonal Frequency Division Multiplexing (OFDM) for modulation. Rather than transmit a high-rate stream of data with a single carrier, OFDM makes use of a large number of closely spaced orthogonal subcarriers that are transmitted in parallel.

Each subcarrier is modulated with a conventional modulation scheme (such as DQPSK, QPSK, 16QAM, 64QAM) at a low symbol rate. The combination of hundreds or thousands of subcarriers enables data rates similar to conventional single-carrier modulation schemes in the same bandwidth.

The diagram in [Figure 3-3](#) illustrates the key features of an OFDM signal in frequency and time. In the frequency domain, multiple adjacent tones or subcarriers are each independently modulated with data. Then in the time domain, guard intervals are inserted between each of the symbols to prevent inter-symbol interference at the receiver caused by multi-path delay spread in the radio channel.

Figure 3-3 OFDM Signal In Frequency and Time Domain

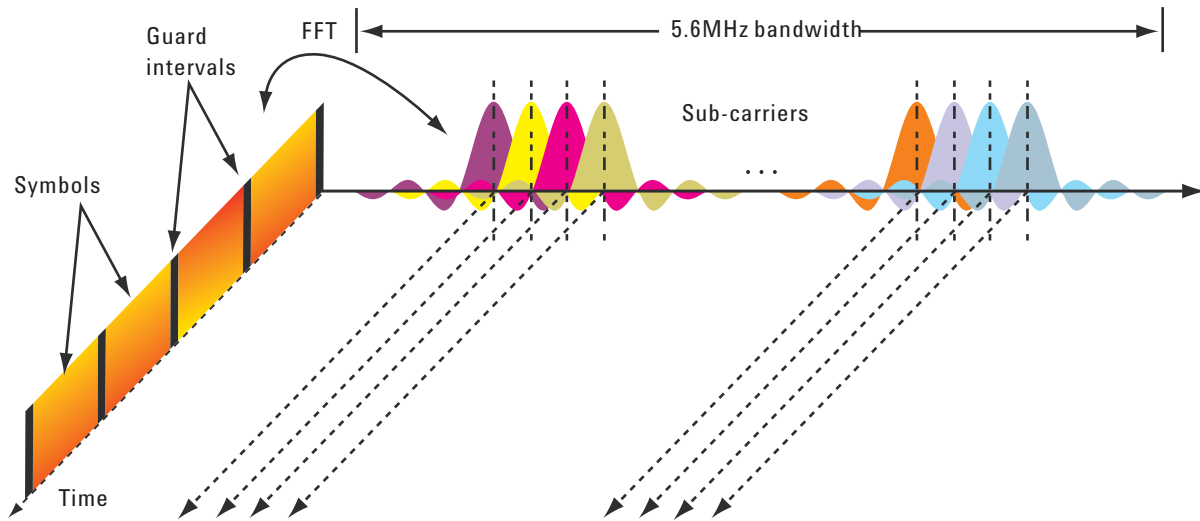

A transmitted OFDM symbol that consists of GI (guard interval) and Effective symbol (the output data of the IFFT) is shown in [Figure 3-4](#). The guard interval is the latter part of effective symbol and inserted without any modification before the effective symbol.

For the GI (Guard interval) in ISDB-T signals, the length can be 1/4, 1/8, 1/16 or 1/32 of the effective symbol length.

Figure 3-4 Structure for OFDM Symbols

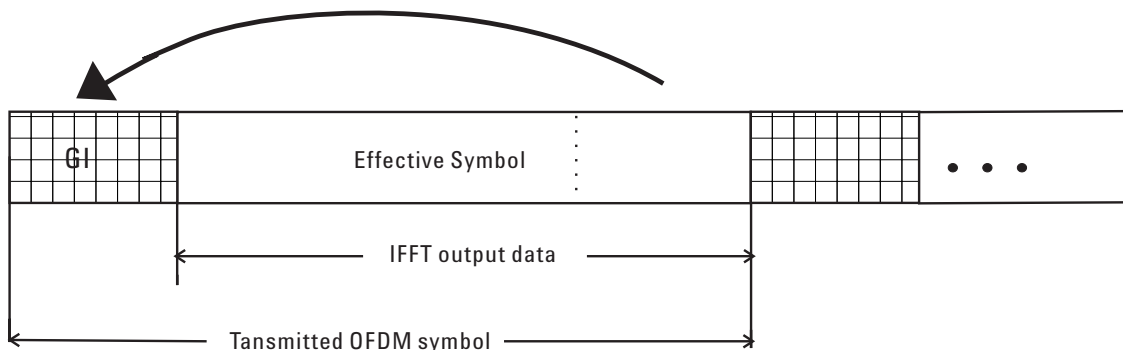

ISDB-Tmm Technical Overview

ISDB-Tmm (Terrestrial Mobile Multi-media) is an extension of the former ISDB-T standard and now is adopted for the nationwide mobile multimedia broadcasting in Japan. It is scheduled to use 207.5 MHz ~ 222 MHz frequency band.

There are a flexible number of segments in ISDB-Tmm signals, from 13 to 33 segments; then the bandwidth can vary approximately from 6 MHz to 14.5 MHz. ISDB-Tmm also offers the flexibility of combining the segments into two different super segment types as below.

- Type A Super segment: 13 segments OFDM frame compliant with ARIB STD B31. A type A super segment can have up to 3 layers.
- Type B Super segment: OFDM frame consisted of less or equal 14 conjugated single segments compliant with ARIB STD B29. The segments in type B super segment can have different configurations.

Figure 3-5 is an example of the ISDB-Tmm frame structure, consisting of two type A super segments (super segment 1 and super segment 3) and one type B super segment (super segment 2). The programmes transmitted in type A super segments can be partially received by a demodulator compliant with ARIB STD B31 and those transmitted in the type B super segments can be received by a demodulator compliant with ARIB STD B29.

Figure 3-5 ISDB-Tmm OFDM Framing Configuration

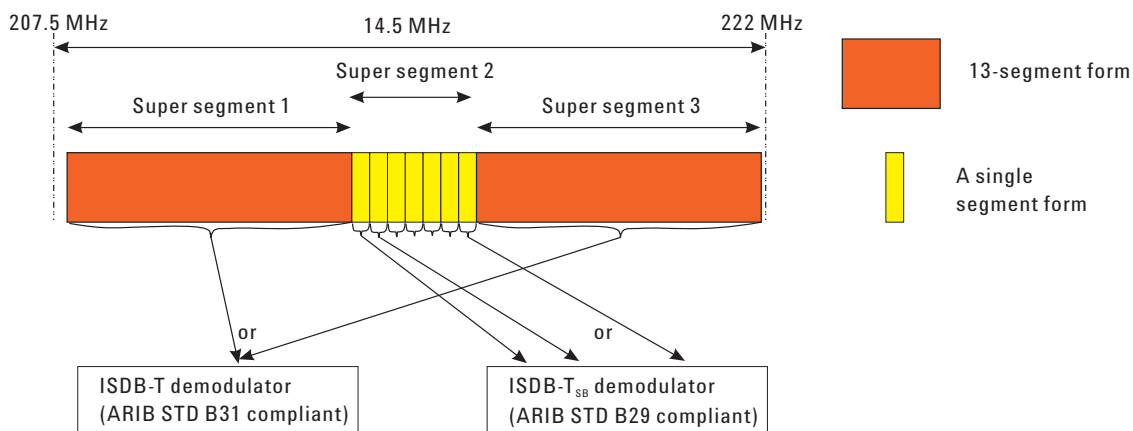

Concatenated transmission is defined as a transmission of multiple segments from the same transmitter with no guard band. ISDB-Tmm use concatenated transmission to combine the super segments together. Figure 3-6 shows an example of the concatenated transmission of 9 transport streams (TS1 ~ TS9). TS1 and TS9 are transmitted through two Type A super segments (13 segments form) and TS2 ~ TS8 are transmitted through a Type B super segment with 7 conjugated single segments.

Figure 3-6 Example of ISDB-Tmm Concatenated Segment Transmission

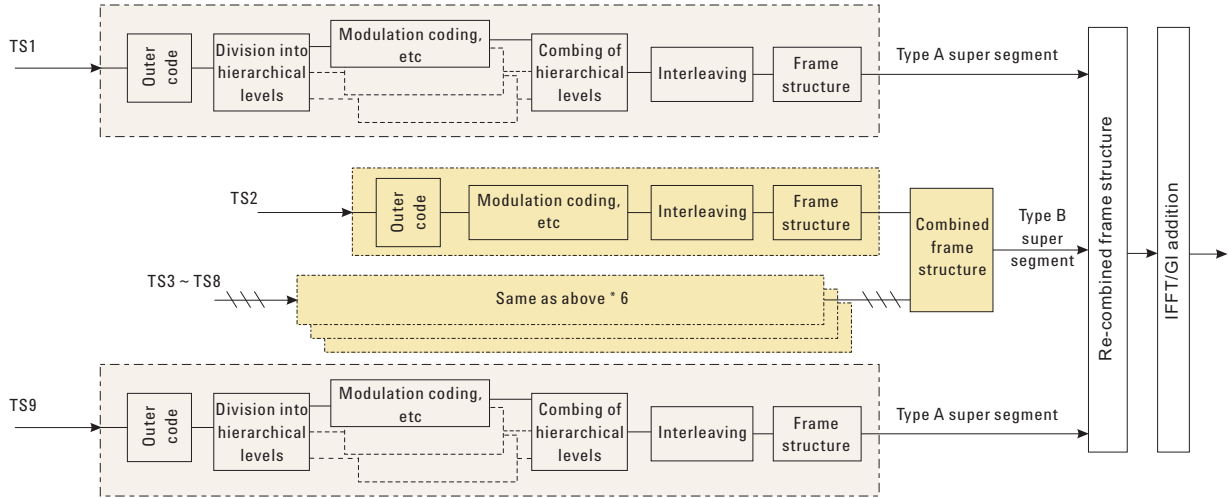

Channel Power Measurement Concepts

Purpose

The Channel Power measurement is an important test in the digital video industry to measure the channel power characteristics of the ISDB-T/Tsb/Tmm radio signal. First of all, it measures the integrated power and power spectral density (PSD) in ISDB-T/Tsb/Tmm defined bandwidth. Secondly, it measures and reports the shoulder attenuation, which is to measure the intermodulation, one of the causes of the OFDM signal quality degradations.

Measurement Method

Channel Power measurement has two views. The measurement methods for each view are described as follows:

RF Spectrum

The RF Spectrum measurement reports the total transmitted power within the channel bandwidth (5.6 MHz for ISDB-T, 14.18 MHz for ISDB-Tmm). The integration bandwidth (IBW) method is used to determine the channel power.

Channel Power is a swept-frequency measurement allowing you to change the RBW and VBW settings manually. To improve repeatability, you can increase the number of averages. The channel power graph is shown in the graph window, while the absolute channel power in dBm and the mean power spectral density in dBm/Hz are shown in the text window.

Shoulder Attenuation

The shoulder attenuation is defined as the difference between the maximum level of the OFDM signal and the maximum level measured at specified frequency range as shown in Figure 3-7. The measurement should be made in the frequency range of -3.3 to -3.5 MHz and +3.3 to 3.5 MHz from the center frequency.[1]

Figure 3-7

Definition of Shoulder Attenuation

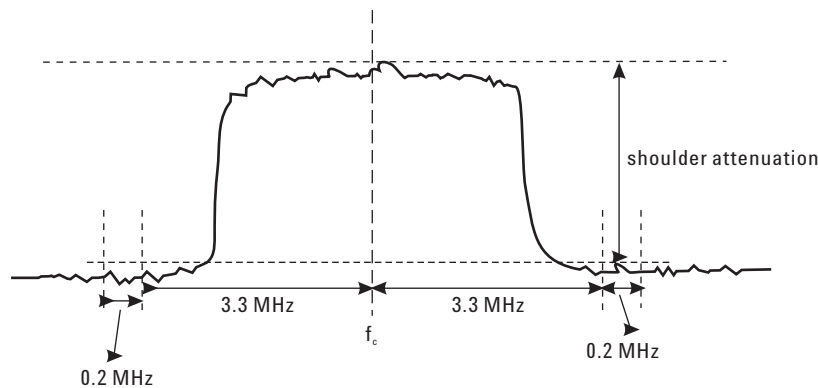

Adjacent Channel Power (ACP) Measurement Concepts

Purpose

Adjacent Channel Power (ACP), as it applies to ISDB-T/Tsb/Tmm, is the power contained in a specified frequency channel bandwidth relative to the total carrier power. It may also be expressed as a ratio of power spectral densities between the carrier and the specified offset frequency band.

As a measurement of out-of-channel emissions, ACP combines both in-band and out-of-band specifications to provide useful figures-of-merit for spectral regrowth and emissions produced by components and circuit blocks without the rigor of performing a full spectrum emissions mask measurement.

Measurement Method

This ACP measurement analyzes the total power levels within the defined carrier bandwidth and at given frequency offsets on both sides of the carrier frequency. This measurement allows the user to specify measurement bandwidths of the carrier channel and each of the offset frequency pairs up to 6. Each pair may be defined with unique measurement bandwidths.

In this measurement, three methods can be used to calculate power.

- **IBW (Integration BW):** The channel integration bandwidth is analyzed using the user defined resolution bandwidth (RBW), which is much narrower than the channel bandwidth.
- **Filter IBW:** This method is useful for improving dynamic range on the signal because a sharp cutoff band pass filter is used.
- **RBW:** This method uses zero-span and an appropriate RBW setting to capture the power level in the carrier channel and the offsets.

If **Total Pwr Ref** is selected as the measurement type, the reference is the total power in carrier channel, and the results are displayed as relative power in dBc and as absolute power in dBm. If **PSD Ref** (Power Spectral Density Reference) is selected, the reference is the PSD in carrier channel, the results are displayed as relative power in dB, and as absolute power in dBm/Hz.

Power Statistics CCDF Measurement Concepts

Purpose

Many digitally modulated signals appear noise-like in the time and frequency domain. This means that statistical measurements of the signals can be a useful characterization. Power Complementary Cumulative Distribution Function (CCDF) curves characterize the higher-level power statistics of a digitally-modulated signal. The curves can be useful in determining design parameters for digital Broadcast systems.

Peak-to-average power ratio is the ratio of the peak envelope power to the average envelope power of a signal. If the peak-to-average power ratio is small, the headroom required in the amplifier to prevent compression of the signal and interference with the adjacent frequency channels is small. Thus, the amplifier can operate more efficiently.

CCDF curves can help you in several situations:

- To determine the headroom required when designing a component.
- To confirm the power statistics of a given signal or stimulus. CCDF curves allow you to verify if the stimulus signal provided by another design team is adequate. For example, RF designers can use CCDF curves to verify that the signal provided by the digital signal processing (DSP) section is realistic.
- To confirm that a component design is adequate or to troubleshoot your subsystem or system design, you can make CCDF measurements at several points of a system.

Measurement Method

The power measured in power statistics CCDF curves is actually instantaneous envelope power defined by the equation:

$$P = (I^2 + Q^2)/Z_0$$

(where I and Q are the quadrature voltage components of the waveform and Z_0 is the characteristic impedance).

Then, to obtain the distribution, make a frequency distribution table in the power calculated above. In this measurement, there are 30001 points ranging from -200 dBm to 100 dBm by 0.01dB. For example, sampled power = 10 dBm, this means the 21000th index point of this table, so increase the variable that is indexed by this power.

After that, the CCDF trace vector can be made. The CCDF means a probability distribution more than any power and the trace starts from average power. The trace is obtained by converting the frequency distribution table of more than average power.

To make the power statistics CCDF measurement, the instrument uses digital signal processing (DSP) to sample the input signal in the channel bandwidth.

The Gaussian distribution line as the band-limited gaussian noise CCDF reference line, the user-definable reference trace, and the currently measured trace can be displayed on a semi-log graph. If the currently measured trace is above the user reference trace, it means that the higher peak power levels against the average power are included in the input signal.

Spectrum Emission Mask Measurement Concepts

Purpose

Spectrum Emission Mask measurements include the in-band and out-of-band spurious emissions. As it applies to ISDB-T/Tsb/Tmm, it is the power contained in a specified frequency bandwidth at certain offsets relative to the total carrier power. It may also be expressed as a ratio of power spectral densities between the carrier and the specified offset frequency band.

As a measurement of out-of-channel emissions, the spectrum emission mask measurement combines both in-band and out-of-band specifications to provide useful figures-of-merit for spectral regrowth and emissions produced by components and circuit blocks without the rigor of performing a full spectrum emissions mask measurement.

Measurement Method

The Spectrum Emission Mask measurement measures spurious signal levels in up to six pairs of offset/region frequencies and relates them to the carrier power. The reference channel integration bandwidth method is used to measure the carrier channel power.

The channel integration bandwidth is analyzed using the user defined resolution bandwidth (RBW), which is much narrower than the channel bandwidth. The measurement computes an average power of the channel or offset/region over a specified number of data acquisitions, automatically compensating for resolution bandwidth and noise bandwidth.

This measurement requires the user to specify measurement bandwidths of the carrier channel and each of the offset/region frequency pairs up to 6. Each pair may be defined with unique measurement bandwidths. The results are displayed both as relative power in dBc, and as absolute power in dBm.

Spectrum Emission Limits Defined by Standard

The following spectrum masks are available in Spectrum Emission Mask measurement:

- Spectrum Mask for ISDB-T defined in Japan ARIB STD-B31, “Methods of Measurement for Digital Terrestrial Broadcasting Transmitters” is shown in [Table 3-2.\[1\]](#)

Table 3-2

Spectrum Mask for ISDB-T Defined in Japan ARIB STD-B31

Difference from carrier frequency	Attenuation relative to the average power, P	Specification
± 2.79 MHz	-27.4 dB/10kHz	upper limit

Table 3-2

Spectrum Mask for ISDB-T Defined in Japan ARIB STD-B31

Difference from carrier frequency	Attenuation relative to the average power, P	Specification
$\pm 2.86 \text{ MHz}$	-47.4 dB/10kHz	upper limit
$\pm 3.00 \text{ MHz}$	-54.4 dB/10kHz	upper limit
$\pm 4.36 \text{ MHz}$	$-57.4 \text{ dB}/10\text{kHz}$ ($P \leq 0.025 \text{ W}$) $-(73.4 + 10\log P) \text{ dB}/10\text{kHz}$ ($0.025 \text{ W} < P \leq 0.25 \text{ W}$) $-67.4 \text{ dB}/10\text{kHz}$ ($P = 0.25 \text{ W}$) $-(73.4 + 10\log P) \text{ dB}/10\text{kHz}$ ($0.25 \text{ W} < P \leq 2.5 \text{ W}$) $-77.4 \text{ dB}/10\text{kHz}$ ($P > 2.5 \text{ W}$)	upper limit

NOTE

The limit on $\pm 4.36 \text{ MHz}$ frequency offset may differ from the values in Table 3-2 in some special transmission environments. To support these test cases, four limits are available, which are Auto Sense, 30dB Mask, 40dB Mask, and 50dB Mask. Table 2-3 on page 29 lists the cases to use these limits.

- Auto Sense means the limits on $\pm 4.36 \text{ MHz}$ frequency offset are the same as the values in Table 3-2, which changes with the channel power automatically.
- 30dB Mask means the limit on $\pm 4.36 \text{ MHz}$ frequency offset is -57.4 dB/10 kHz.
- 40dB Mask means the limit on $\pm 4.36 \text{ MHz}$ frequency offset is -67.4 dB/10 kHz.
- 50dB Mask means the limit on $\pm 4.36 \text{ MHz}$ frequency offset is -77.4 dB/10 kHz.

- Spectrum mask for ISDB-T defined in Brazil ABNT NBR 15601, “Digital terrestrial television - Transmission system” is shown in Table 3-3.[4]

Table 3-3

Spectrum Mask for ISDB-T Defined in Brazil ABNT NBR 15601

Difference from carrier frequency	Minimum attenuation in relation to average power measured at carrier central frequency		
	Non-critical mask	Sub-critical mask	Critical mask
$\pm 2.79 \text{ MHz}$	0.0 dB/10kHz	0.0 dB/10kHz	0.0 dB/10kHz
$\pm 2.86 \text{ MHz}$	20.0 dB/10kHz	20.0 dB/10kHz	20.0 dB/10kHz
$\pm 3.00 \text{ MHz}$	27.0 dB/10kHz	34.0 dB/10kHz	34.0 dB/10kHz

Table 3-3 *Spectrum Mask for ISDB-T Defined in Brazil ABNT NBR 15601*

Difference from carrier frequency	Minimum attenuation in relation to average power measured at carrier central frequency		
	Non-critical mask	Sub-critical mask	Critical mask
±3.15 MHz	36.0 dB/10kHz	43.0 dB/10kHz	50.0 dB/10kHz
±4.5 MHz	53.0 dB/10kHz	60.0 dB/10kHz	67.0 dB/10kHz
±9.0 MHz	83.0 dB/10kHz	90.0 dB/10kHz	97.0 dB/10kHz
±15.0 MHz	83.0 dB/10kHz	90.0 dB/10kHz	97.0 dB/10kHz

Three spectrum masks are defined as shown above. The application of the spectrum masks depends on the class of the stations and substations.

According to [4], digital stations are classified in Special Class, Class A, Class B and Class C as shown in Table 3-4.

Table 3-4 *Classification of the Digital Stations*

Class	Maximum ERP power* (height = 150m) kW	
	VHF high	UHF
Special	16	80
A	1.6	8
B	0.16	0.8
C	0.016	0.08

* ERP power is the effective radiated power

The criteria for using non-critical, sub-critical and critical spectrum masks are shown in Table 3-5.

Table 3-5 Criteria for Using Non-critical, Sub-critical and Critical Spectrum Masks

Digital Station class	A, B and C				Special		
Distance in relation to the adjacent channel installed in the same location	<400 m		>400m		Absence of adjacent channel foreseen of installed in the same location	Presence of adjacent channel foreseen or installed in the same location	Absence of adjacent channel foreseen of installed in the same location
Type of channel modulation of the adjacent channel foreseen or installed in the same location	Analog	Digital	Analog	Digital			
$P_{\text{digital}} < P_{\text{adjacent}} + 3 \text{ dB}$	Critical	Sub-critical	Critical		Non-critical	Critical	
$P_{\text{digital}} > P_{\text{adjacent}} + 3 \text{ dB}$		Critical					
P_{digital} = ERP Power of the digital station P_{adjacent} = ERP Power of the adjacent channel station							

- Spectrum masks for ISDB-Tsb defined in Brazilian Standard ARIB STD-B29, “Transmission System for Digital Terrestrial Sound Broadcasting” are shown in [Table 3-6](#) and [Table 3-7](#). [3]

Spectrum mask in [Table 3-6](#) is used when the ISDB-Tsb signal contains 1 segment, and spectrum mask in [Table 3-7](#) is used when the ISDB-Tsb signal contains 3 segments.

Table 3-6 Spectrum Mask for ISDB-Tsb 1-Segment Defined in ARIB STD-B29

Difference from carrier frequency	Attenuation from the average power	Specification
$\pm 220 \text{ kHz}$	-16.3 dB/10kHz	upper limit
$\pm 290 \text{ kHz}$	-36.3 dB/10kHz	upper limit
$\pm 360 \text{ kHz}$	-46.3 dB/10kHz	upper limit
$\pm 1170 \text{ kHz}$	$-52.0 \text{ dB}/10\text{kHz}$ ($P \leq 0.5 \text{ W}$) $-(53.6 + 5.6 \log P) \text{ dB}/10\text{kHz}$ ($0.5 \text{ W} < P \leq 5.0 \text{ W}$) $-57.6 \text{ dB}/10\text{kHz}$ ($P > 5.0 \text{ W}$)	upper limit

Table 3-7 Spectrum Mask for ISDB-Tsb 3-Segment Defined in ARIB STD-B29

Difference from carrier frequency	Attenuation from the average power	Specification
± 650 kHz	-21.0 dB/10kHz	upper limit
± 720 kHz	-41.0 dB/10kHz	upper limit
± 790 kHz	-51.0 dB/10kHz	upper limit
± 2220 kHz	-61.0 dB/10kHz ($P \leq 0.5$ W) $-(45.1 + 10\log P)$ dB/10kHz (0.5 W < $P \leq 5.0$ W) -71.0 dB/10kHz ($P > 5.0$ W)	upper limit

Amplitude Correction in Spectrum Emission Mask Measurement

The dynamic range of the RF output of a real ISDB-T/Tsb transmitter typically exceeds that of the analyzer, therefore, if you measure the spectrum emission mask directly, the result is always “FAIL”, which does not reflect the real RF output.

To measure the spectrum emission mask of the transmitter’s RF output, there are two methods.

- If the ISDB-T/Tsb transmitter has a mask filter, the diagram for Spectrum Emission Mask measurement is shown in Figure 3-8.

Figure 3-8 Diagram for Spectrum Emission Mask Measurement on ISDB-T/Tsb Transmitter

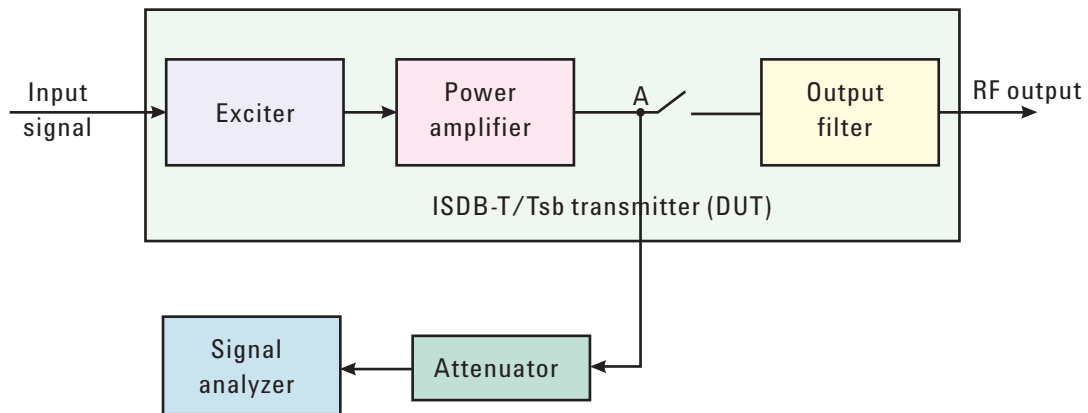

The steps for measuring the Spectrum Emission Mask are as follows:

- Measure the frequency response of the output filter using a network analyzer or a combination of signal source and signal analyzer.
- Measure the signal transmitted at point A as shown in Figure 3-8.
- Apply amplitude correction on spectrum value measured in step b using the filter’s response from step a.

The correction data is typically a table of the filter's frequency response values, in dB, at a number of frequency points across the band.

- If the transmitter doesn't have the mask filter, an external filter with a band-block filter frequency response should be added after the transmitter for measurement arrangement as shown in [Figure 3-9](#).

Figure 3-9 Diagram for Spectrum Emission Mask Measurement on ISDB-T/Tsb Transmitter without Output Filter

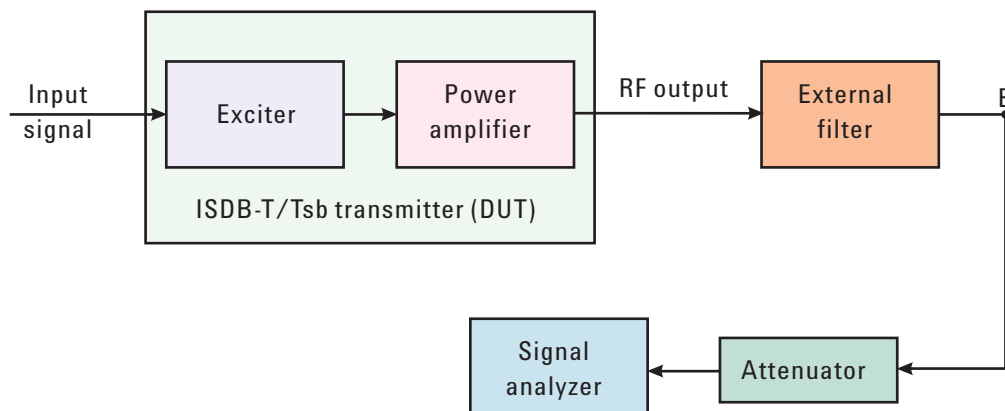

The steps for measuring the Spectrum Emission Mask is as follows:

- a. Measure the frequency response of the external filter using a network analyzer or a combination of signal source and signal analyzer.
- b. Measure the signal transmitted at point B as shown in [Figure 3-9](#).
- c. Apply amplitude correction on spectrum value measured in step b using the filter's response from step a.

The correction data is typically a table including the negative value of the filter's frequency response in dB at a number of frequency points across the band.

Modulation Accuracy Measurement Concepts

Purpose

Measurement of modulation accuracy and quality is necessary to meet ISDB-T/Tsb/Tmm defined tests and to ensure proper operation of the transmitters. This measurement takes into account all possible error mechanisms in the entire transmission chain including baseband filtering, I/Q modulation anomalies, filter amplitude and phase non-linearities, and power amplifier distortion. This measurement provides an overall indication of the performance level of the transmitter of the UUT.

Measurement Method

Modulation Accuracy measurement measures the performance of the transmitter's modulation circuitry.

In a digitally modulated signal, it is possible to predict what the ideal magnitude and phase of the carrier should be at any time, based on the received data sequence. The transmitter's modulated signal is compared to an ideal signal vector. The difference between these two vectors is sampled and processed using DSP.

In the modulation accuracy measurement, the following data is provided:

- EVM - peak and rms error vector magnitude
- MER - power ratio of the sum of squares of the ideal symbol vectors' magnitude to the sum of squares of the symbol error vectors' magnitude
- Magnitude Error - difference in amplitude between I/Q measured signal and I/Q reference signal
- Phase Error - difference in phase between the I/Q measured signal and I/Q reference signal
- Freq Error - the frequency difference between the transmitter's actual center frequency and the analyzer's center frequency
- Quad Error - the orthogonal error between I and Q signals
- Amplitude Imbalance - a form of IQ gain imbalance
- TMCC Decoding results (only for ISDB-T/Tsb)
- AC Decoding results (only for ISDB-T/Tsb)

MER Measurement Method

The system diagram of the transmitter defined in JEITA handbook is shown in [Figure 3-10](#). The measurement points of MER can be B,C,D, and E.

In the analyzer, the signal is first converted to low IF frequency. After that, AD sampling is performed. And then the sampled data is processed as follows to calculate MER.[\[1\]](#)

- a. Detect the OFDM symbol.
- b. Detect the carrier frequency offset.
- c. Correct the frequency according to the carrier frequency offset.
- d. Extract the waveform for each OFDM symbol and perform a FFT.
- e. Perform equalization regarding the transmission path using SP (Scattered Pilot) information.
- f. Calculate the MER with the formula described in “MER” on page 98.

Figure 3-10 System Diagram of Transmitter

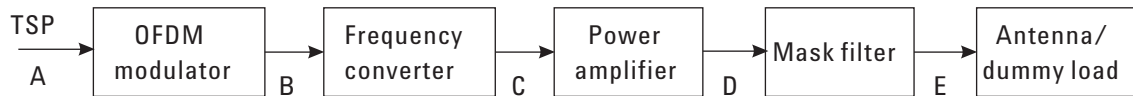

Definition of the Measurement Parameter

The detailed description of the parameters above is as follows:

EVM

EVM (Error Vector Magnitude) is a modulation quality metric widely used in digital broadcast systems. It is defined as:

$$EVM = \frac{\sqrt{\frac{1}{N} \sum_{j=1}^N (\delta I_j^2 + \delta Q_j^2)}}{S_{rms}} \times 100\%$$

Where N is the number of data points in the measurement samples. S_{rms} is calculated

in the following way:
$$S_{rms} = \sqrt{\frac{1}{N} \sum_{j=1}^N (I_j^2 + Q_j^2)}$$

The representation of other definitions are expressed in Figure 3-11.

Figure 3-11

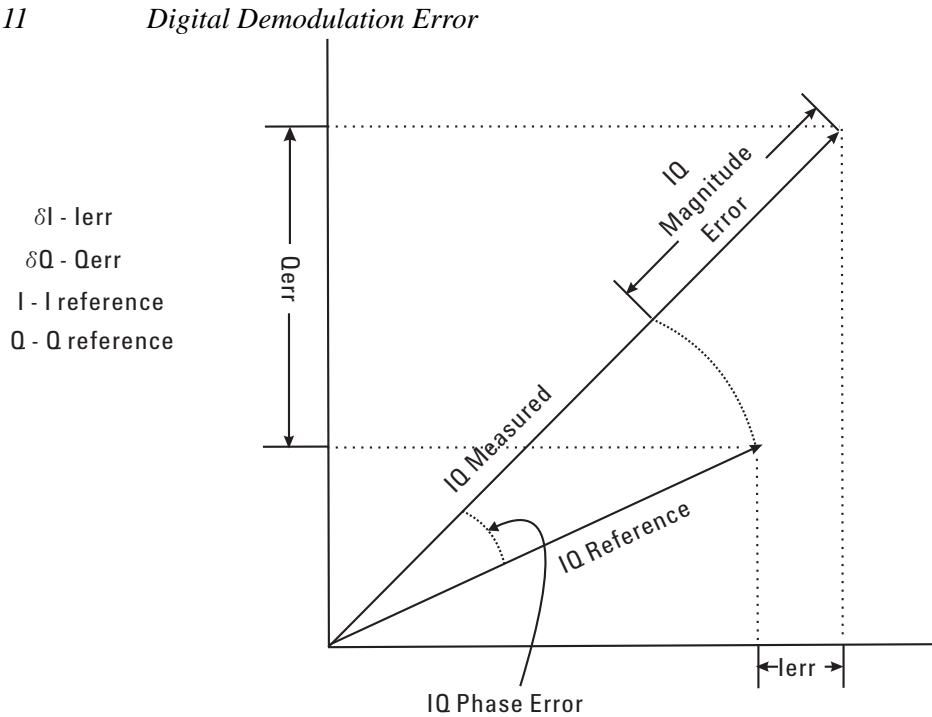

MER

MER (Modulation Error Ratio) is a power ratio expressed in dB of the sum of squares of the magnitude of the ideal symbol vectors to the sum of the squares of the magnitudes of the symbol error vectors.

The MER is calculated as below:

$$MER = 10 \log_{10} \left[\frac{\sum_{j=1}^N (I_j^2 + Q_j^2)}{\sum_{j=1}^N (\delta I_j^2 + \delta Q_j^2)} \right] dB$$

N is the number of data points in the measurement samples.

The representations of other definitions are expressed in Figure 3-11.

Magnitude Error

Magnitude error is the difference in amplitude between the I/Q measured signal and the I/Q reference signal which is shown in Figure 3-11.

Phase Error

Phase error is the difference in phase between the I/Q reference signal and the I/Q measured signal for composite signal. Phase Error is shown in Figure 3-11.

Frequency Error

Frequency error shows the signal carrier frequency-error relative to analyzer's center frequency. This parameter is displayed in Hz and is the amount of frequency shift, from the analyzer's center frequency, that the analyzer must perform to achieve carrier lock.

Errors in RF frequency, LO frequency, or digitizer clock rate could all appear as carrier frequency error.

Quad Error

Quad error (Quadrature Skew Error) indicates the orthogonal error between the I and Q signals.

Ideally, I and Q should be orthogonal (90 degrees apart). A quadrature skew error of 3 degrees means I and Q are 93 degrees apart. A quadrature skew error of -3 degrees means I and Q are 87 degrees apart.

Amplitude Imbalance

Amplitude imbalance is another form of IQ Gain imbalance. It is calculated from the formula below:

$$AI = 20 \log_{10} \frac{v_I}{v_Q} \text{ dB}$$

Where v_I and v_Q represent I and Q gain respectively.

SFN Reception Conditions and FFT Start Position

A single frequency network (SFN) is a broadcast network where several transmitters send the same signal on the same frequency channel simultaneously without causing interference. In SFN, receivers can receive signals from several transmitters at the same time, resulting in complex reception conditions. Generally, three multi-path patterns are considered while analyzing signals from SFN network, which are pre-echo, post echo, and 0 dB echo. See Figure 3-12 for the impulse response of these three pattern, where y-axis is the amplitude of impulse response and x-axis is time.

Figure 3-12

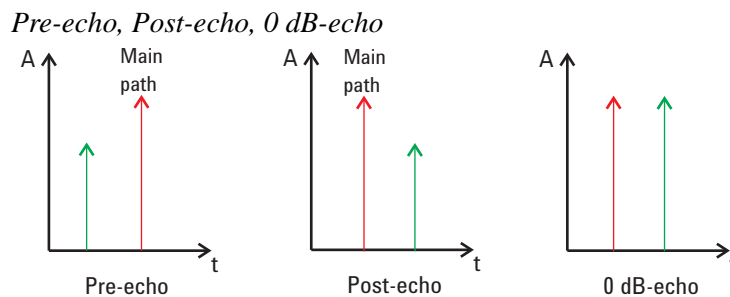

- Pre-echo means the strongest path arrives after a lower path, which usually takes place when using repeaters. The LOS (line of sight) signal arrives first but with lower level than the signal from the repeater.

- Post-echo is the most common case, in which the strongest path is from the nearest transmitter tower and other paths are either from farther transmitters or from reflection.
- 0 dB-echo is the worst case for receiver which consists of two paths with equal level. The two paths may come from two transmitters with equal distance to the receiver or from repeaters.

FFT start position, as shown in Figure 3-13, is defined as the start point of the FFT window used to recover the OFDM carriers. It is crucial for MER and channel impulse response measurements in SFN tests because of complex reception conditions mentioned above. There are nine options from 0/8 GI ~ 8/8 GI with 1/8 GI interval available for choice.

Figure 3-14 illustrates the relationship between the FFT start position and pre-echo/post-echo. The FFT start position should set to make sure the a minimum of inter-symbol interference (ISI) occurs and to include as many echoes as possible within the FFT window. "No ISI range" in Figure 3-14 indicates the FFT start point range with no ISI, where there is no overlap with the preceding and subsequent symbols.

Figure 3-13

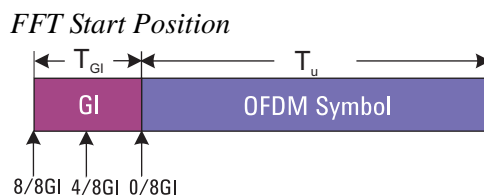
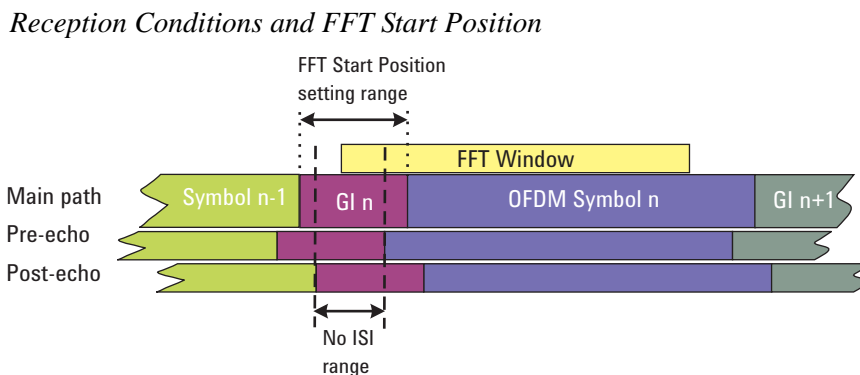

Figure 3-14



The measurement range for channel impulse response is $-1/2 T_u \sim 1/2 T_u$, where T_u is the duration of the OFDM symbol. If all the echoes are within GI range, the signals should be well reconstructed by adjusting the FFT start position. If there are echoes outside the GI range, the results would depend on the delay and level of the echo.

To adjust the FFT start position value, it is recommended to begin with 4/8 GI to cover both pre-echoes and post echoes. Then check the MER result with different FFT start position. The optimal FFT start position will lead to best MER result.

Peak Table

Peak table window enables you to view the amplitude and delay of each path when there is more than one path in the signal channel. Here is an example of channel impulse response of a two-path channel with 0 and 20 us delay respectively.

You can customize the peak table measurement as following:

- Press **Peak Search, More 1 of 2, Peak Criteria, Pk Excursion, 10, dB, Pk Threshold, -60, dB** and then toggle **PK Threshold Line** to **On** to set the criteria for peak. To see how the Pk Excursion and Pk Threshold affect the peak criteria, refer to **“Peak Criteria” on page 101**.
- Press **Peak Search, More 1 of 2, Peak Table, Peak Limit** to set the value of the peak limit line and turn on or turn off the peak limit function.

The multi-path measurement result should look like **Figure 3-15**, including peak threshold line, peak excursion, and peak limit line.

Figure 3-15

Channel Impulse Response of a Two-Path Channel

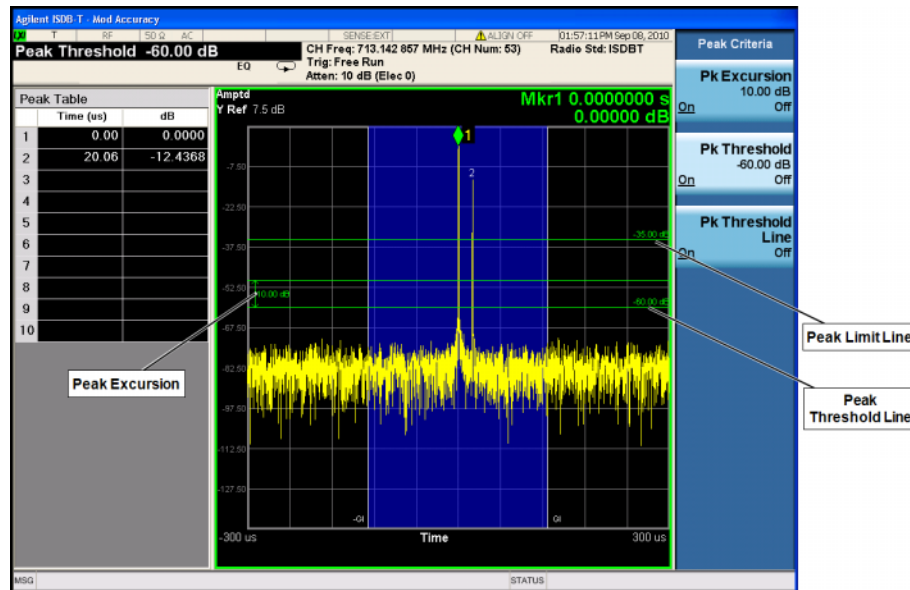

Peak Criteria

How can a signal be identified as a peak? This section describes the criteria for peak, which involves mainly two parameters: Peak Excursion and Peak Threshold.

Peak (Pk) Excursion: This value determines the minimum amplitude variation (rise and fall) required for a signal to be identified as a peak.

Peak (Pk) Threshold: This value defines the minimum signal level that the peak identification algorithm uses to recognize a peak.

Concepts

Modulation Accuracy Measurement Concepts

If both Pk excursion and Pk Threshold are on, a signal must rise above the Pk threshold value by at least the Peak Excursion value and then fall back from its local maximum by at least Peak Excursion value to be considered as a peak. As shown in [Figure 3-16](#), only when both $d1$ and $d2$ are more than or equal to the value of peak excursion, point A can be identified as a peak.

Figure 3-16

Peak Criteria

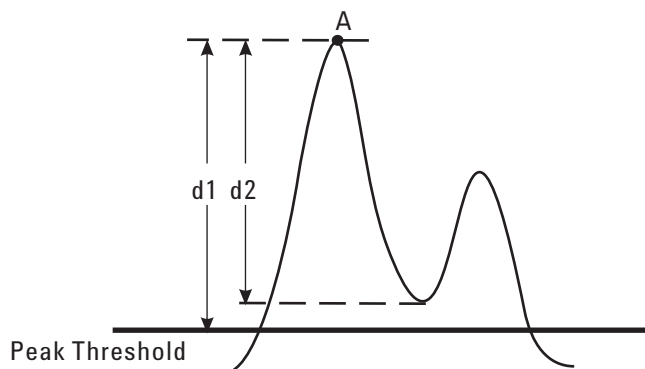

Occupied Bandwidth Measurement Concepts

Purpose

Occupied Bandwidth measurements express the percentage of the transmitted power within a specified bandwidth. This percentage is typically 99%.

The spectrum shape of an ISDB-T/Tsb/Tmm signal can give useful qualitative insight into transmitter operation. Any distortion to the spectrum shape can indicate problems in transmitter performance.

Measurement Method

The instrument uses sweep mode to capture the data and the total power within the measurement frequency span is integrated for its 100% of power. The frequencies of 0.5% of the total power are then calculated to get 99.0% bandwidth.

Monitor Spectrum Measurement Concepts

Purpose

The Monitor Spectrum measurement provides spectrum analysis capability for the instrument. It is used as a quick, convenient means of looking at the entire spectrum. While the look and feel are similar to the Spectrum Analyzer mode, the functionality is greatly reduced for easy operation. The main purpose of the measurement is to show the spectrum. The default span should cover an appropriate frequency range of the application.

Measurement Method

The measurement takes the sweep and acquires the data between the start frequency and stop frequency, then trace is displayed in the measurement window.

Troubleshooting Hints

Changes made by the user to advanced spectrum settings, particularly to ADC range settings, can inadvertently result in spectrum measurements that are invalid and cause error messages to appear. Care needs to be taken when using advanced features.

IQ Waveform Measurement Concepts

Purpose

The IQ Waveform measurement is a generic measurement for viewing the input signal waveforms in the time domain. This measurement is how the instrument performs the zero span functionality found in traditional spectrum analyzers.

Basic mode waveform measurement data may be displayed using either a Signal Envelope window, or an I/Q window which shows the I and Q signal waveforms in parameters of voltage versus time. The advantage of having an I/Q view available while making a waveform measurement is that it allows you to view complex components of the same signal without changing settings or measurements.

The waveform measurement can be used to perform general purpose power measurements in the time domain with excellent accuracy.

Measurement Method

The instrument makes repeated power measurements at a set frequency, similar to the way a swept-tuned spectrum analyzer makes zero span measurements. The input analog signal is converted to a digital signal, which then is processed into a representation of a waveform measurement. The measurement relies on a high rate of sampling to create an accurate representation of a time domain signal.

Baseband I/Q Inputs (Option BBA) Measurement Concepts

The N9020A Option BBA Baseband I/Q Inputs provides the ability to analyze baseband I/Q signal characteristics of mobile and base station transmitters. This option may be used only in conjunction with the following modes:

- IQ Analyzer (Basic)
- 802.16 OFDMA (WiMAX/WiBro)
- cdma2000
- GSM/EDGE
- TD-SCDMA
- DTMB (CTTB)
- DVB-T/H with T2
- ISDB-T
- CMMB
- Digital Cable TV

What are Baseband I/Q Inputs?

Option BBA consists of a Baseband Input module, four input connectors, and a calibration output connector. The connectors are at the left side of the front panel. The two ports labeled “I” and “Q” are the “unbalanced” inputs.

An unbalanced or “single-ended” baseband measurement of an I or Q signal is made using a probe connected to the I or Q connector. A simultaneous I/Q unbalanced single-ended measurement may be made using two probes connected to the I and Q input connectors.

If “balanced” signals are available, they may be used to make a more accurate measurement. Balanced signals are signals present in two separate conductors, are symmetrical about ground, and are opposite in polarity, or out of phase by 180 degrees.

Measurements using balanced signals can have a higher signal to noise ratio resulting in improved accuracy. Noise coupled into each conductor equally in a “common mode” to both signals may be separated from the signal. The measure of this separation is “common-mode rejection”.

To make a balanced measurement, the two connectors labeled “I” and “Q” are used in conjunction with the I and Q inputs. The terms “I-bar” and “Q-bar” may be applied to the signals, as well as the inputs themselves. Probes (customer provided) must be used to input balanced baseband I/Q signals. This may be referred to as a balanced measurement.

Balanced baseband measurements are made using the I and connectors for I only signal measurements, while the Q and connectors are used for a Q only signal measurement. Balanced measurements of I/Q require differential probe connections to all four input connectors. For details of probe selection and use, refer to [“Selecting Input Probes for Baseband Measurements” on page 108.](#)

What are Baseband I/Q Signals?

In transmitters, the term baseband I/Q refers to signals that are the fundamental products of individual I/Q modulators, before the I and Q component signals are combined, and before upconversion to IF or RF frequencies.

In receivers, baseband I/Q analysis may be used to test the I and Q products of I/Q demodulators, after a RF signal has been downconverted and demodulated.

Why Make Measurements at Baseband?

Baseband I/Q measurements are a valuable means of making qualitative analyses of the following operating characteristics:

- I/Q signal layer access for performing format-specific demodulation measurements (for example, ISDB-T, CMMB, W-CDMA).
- Modulation accuracy – that is, I/Q plane metrics:
 - error vector magnitude; rms, peak
 - frequency error
 - magnitude and phase errors
- CCDF of $I^2 + Q^2$
- Basic analysis of I and Q signals in isolation including: DC content, rms and peak to peak levels, CCDF of each channel

Comparisons of measurements made at baseband and RF frequencies produced by the same device are especially revealing. Once signal integrity is verified at baseband, impairments can be traced to specific stages of upconversion, amplification, or filtering by RF analysis. In addition, impairments to signal quality that are apparent at RF frequencies may be traceable to baseband using baseband analysis.

Selecting Input Probes for Baseband Measurements

The selection of baseband measurement probe(s) and measurement method is primarily dependent on the location of the measurement point in the circuit. The probe must sample voltages without imposing an inappropriate load on the circuit.

The system supports a variety of 1 M Ω impedance input passive probes as well as the Keysight 1153A active differential probe using the InfiniMax probe interface.

The Keysight 1153A active probe can be used for both single-ended and differential measurements. In either case a single connection is made for each channel (on either the I or Q input). The input is automatically configured to 50 Ω single-ended type measurement and the probe power is supplied through the InfiniMax interface. The probe can be configured for a variety of input coupling and low frequency rejection modes. In addition, a wide range of offset voltages and probe attenuation accessories are supported at the probe interface. The active probe has the advantage that it does not significantly load the circuit under test, even with unity gain probing.

With passive 1 M Ω probes, the probe will introduce a capacitive load on the circuit, unless a higher attenuation is used at the probe interface. Higher attenuation helps isolate the probe, however, it reduces the signal level and degrades the signal-to-noise-ratio of the measurement. Passive probes are available with a variety of attenuation values for a moderate cost. Many Keysight passive probes can be automatically identified by the system, setting the input impedance required as well as the nominal attenuation. For single-ended measurements a single probe is used for each channel. Other passive probes can be used, after manually setting the attenuation and probe impedance configurations.

For full differential measurements, the system supports probes on each of the four inputs. The attenuation for each of the probes should be the same for good common mode rejection and channel match.

Supported Probes

The following table lists the probes currently supported by Option BBA:

Probe Type	Model Number	Description
Active	1130A	1.5 GHz differential probe amp (No probe head)
	1131A ^a	InfiniMax 3.5 GHz probe
	1132A ^a	InfiniMax 5 GHz probe
	1133A ^a	InfiniMax 7 GHz probe
Passive	1161A	Miniature passive probe, 10:1, 10 M Ω , 1.5 m

- a. Probe heads are necessary to attach to your device properly. Probe connectivity kits such as the E2668A, E2669A or E2675A are needed. For more details, refer to the Keysight probe configuration guide, 5968-7141EN and 5989-6162EN.

Probes without Stored Calibration

The following 115xA active probes may be used with the MXA's baseband IQ inputs and may use the same probe calibration utility software. However, the probe calibration data is not stored in the MXA and will be lost if power is cycled. Use of the E2655B de-skew and calibration kit, including the calibration fixture, is required because of the different physical configuration of the probes. (The physical connections are different mechanically, not electrically.)

Probe Type	Model Number	Description
Active	1153A	200MHz differential probe
	1156A	Active probe, 1.5 GHz
	1157A	Active probe, 2.5 GHz
	1158A	Active probe, 4 GHz

Refer to the current Keysight probe data sheet for specific information regarding frequency of operation and power supply requirements.

Baseband I/Q Measurement Views

Measurement result views made in the IQ Analyzer (Basic) mode are available for baseband signals if they relate to the nature of the signal itself. Many measurements which relate to the characteristics that baseband I and Q signals have when mixed and upconverted to signals in the RF spectrum can be made as well. However, measurements which relate to the characteristics of an upconverted signal that lie beyond the bandwidth available to the Baseband I/Q Input circuits can not be measured (the limits are dependent on the installed options: Standard – 10 Hz to 20 MHz, Option B25 – 10 Hz to 50 MHz, and Option S40 – 10 Hz to 80 MHz).

At RF frequencies, power measurements are conventionally displayed on a logarithmic vertical scale in dBm units, whereas measurements of baseband signals using Baseband I/Q inputs may be conveniently displayed as voltage using a linear vertical scale as well as a log scale.

Spectrum Views and 0 Hz Center Frequency

To view the Spectrum display of I only or Q only signals, use the Complex Spectrum measurement capability in IQ Analyzer (Basic) Mode.

I only and Q only Spectrum views are conventional, displayed with 0 Hz at the left side of the horizontal axis. When upconverted or multiplied, an I only or Q only signal could ultimately lie above or below the carrier center frequency, but in either case it will only occupy half the bandwidth.

Waveform Signal Envelope Views of I only or Q only

To view the Signal Envelope display of I only or Q only signals, use the Waveform measurement capability in IQ Analyzer (Basic) Mode.

The I and Q Waveform of an I/Q signal is very different from the complex signal displayed in the RF Envelope view. That is because the RF Envelope is a product of both the I and Q modulation waveforms.

However, an I and Q Waveform measurement of an I only or Q only signal is exactly the same signal displayed in the RF Envelope view. That is because an I only or Q only waveform determines the I only or Q only signal envelope. Thus, the RF Envelope view can be used to measure an I only or Q only waveform directly.

Other Sources of Measurement Information

Additional measurement application information is available through your local Keysight Technologies sales and service office. The following application notes treat digital communications measurements in much greater detail than discussed in this measurement guide.

- Application Note
Spectrum Analysis Basics
Keysight part number 5952-0292E
- Application Note
Digital Modulation in Communications Systems - An Introduction
Keysight part number 5965-7160E
- Application Note
Characterizing Digitally Modulated Signals with CCDF Curves
Keysight part number 5968-5858E

Go to http://www.keysight.com/find/digital_video to find more products and literatures on digital video transmitter and receiver measurements.

Instrument Updates at www.keysight.com

These web locations can be used to access the latest information about the instrument, including the latest firmware version.

<http://www.keysight.com/find/cxa>

<http://www.keysight.com/find/exa>

<http://www.keysight.com/find/mxa>

<http://www.keysight.com/find/pxa>

References

- [1] JEITA handbook: Methods of Measurement for Digital Terrestrial Broadcasting Transmitters
- [2] ARIB STD-B31 Transmission System for Digital Terrestrial Television Broadcasting
- [3] ARIB STD-B29 Transmission System for Digital Terrestrial Sound Broadcasting
- [4] ABNT NBR 15601 Brazilian Standard: Digital terrestrial television - Transmission System
- [5] ARIB STD-B46 Transmission System Based on Connected Segments for Terrestrial Mobile Multimedia Broadcasting